



7th EDITION

# Florida High Wind Concrete and Clay Tile Installation Manual



FRSA-TRI Alliance December 31, 2023 (12-31-23)



## PREFACE

The Tile Roofing Industry Alliance (TRI) in partnership with the Florida Roofing and Sheet Metal Contractors Association, Inc. (FRSA) have been working together for over two decades on the development of installation manuals that represent proper installation practices, industry standards and the latest roof tile code requirements for Florida.

It was the consensus of a joint committee that we should re-write this manual in a way that addresses the latest wind codes, recognizes the latest products and provides clarity for contractors and inspectors regarding which products and processes are acceptable in the High Wind regions. The committee also adopted recommendations for enhanced installation practices to improve the long-term performance of tile roofing systems. The culmination of the committee's efforts led to the creation of this 7th Edition Florida High Wind Concrete and Clay Tile Installation Manual for High Wind Applications in Florida.

## LIMITATIONS ON USE AND DISCLAIMER FOR THE FRSA-TRI INSTALLATION GUIDE

These tile guidelines are a consensus document developed by a joint committee of the Florida Roofing and Sheet Metal Contractors Association, Inc. (FRSA) and the Tile Roofing Industry Alliance (TRI). It is important to recognize that these recommendations are neither warranties, explicit or implicit, or representative of the only method by which a tile system can be installed. Rather, they try to summarize for the designer, applicator or developer good roofing practices and some of the industry standards for the installation of the roof tiles which have been developed over time from actual trade practice and the requirements of various building code agencies. These guidelines may not be applicable in all geographical areas. It is the responsibility of those individuals who are referring to these guidelines to independently research and determine which method is best for their particular project.

## INTRODUCTION

The recommendations contained herein address concrete and clay tile installations in Florida; however these recommendations may be utilized in other geographical areas designated as a High Wind region. The TRI offers installation manuals for basic Climate regions as well as Cold and Snow regions. For more information, visit the TRI website [www.tilerroofing.org](http://www.tilerroofing.org) or email [info@tilerroofing.org](mailto:info@tilerroofing.org).

The manner in which tile roofs are installed in High Wind regions makes them a highly-effective water shedding assembly that affords years of service and protection. The effectiveness of a tile roof system as a weather resistant assembly depends upon the proper installation of the tile roof components, because installing them properly is critical to the performance of the installed system.

The matrix for underlayment and flashings (see page 6) addresses the compatibility of one-ply and two-ply underlayments, attachment methods and flashing types, as well as the possible need for additional flashings and sealants. The hip and ridge attachment table (see page 14) denotes the various approved methods for installing hip and ridge tiles, as well as the compatible weather blocking treatments. These tables will help reduce the likelihood of the inadvertent "mixing of systems," which can lead to a reduction in the life span of a tile roof system.

This manual has been divided into two sections of content. The first contains text and tables; the second contains detailed drawings that supplement the text.

Designers should be familiar with local codes and wind zone designations when choosing a tile roof system. For more information, please contact the Tile Roofing Industry Alliance (TRI) or the Florida Roofing and Sheet Metal Contractors Association, Inc. (FRSA). Initial publication date 8/22, effective code date 12/31/23.

## TABLE OF CONTENTS

**SPECIFICATIONS**

General Overview .....	3
Products .....	3
Underlayment & Flashings Matrix.....	6

**INSTALLATION**

Single-Ply System .....	7
Two-Ply System .....	8
Metal Flashings.....	9
Tile Installation .....	12
Hip and Ridge Installation .....	14

**APPENDIX A**

Roof Project Design Flow Chart and Examples .....	18-21
Uplift and Design Pressure Tables .....	22-31
ASCE 7-22 Wind Map For Exposure C.....	32

**APPENDIX B**

Drawings .....	33-48
----------------	-------

**APPENDIX C**

Glossary .....	49-53
----------------	-------

## GENERAL OVERVIEW

**Related Work Specified Elsewhere** – Other trades such as Rough Carpentry – Section 06 10 00, Roof and Deck Insulation – Section 07 22 00, Flashing and Sheet Metal – Section 07 60 00, and Roof and Wall Specialties and Accessories – Section 07 70 00, are not covered by these recommendations.

**Quality Assurance** – Concrete roof tile shall be in compliance with ASTM C1492. Clay roof tile shall be in compliance with ASTM C1167.

**Submittals** – When required, submittals shall include the tile profile, color and manufacturer. A typical submittal package includes product descriptions, recommended installation procedures and a conforming Product Approval or current Compliance Report.

**Product Delivery, Storage and Handling** – Distribute stacks of tile uniformly, not in concentrated loads. When conditions warrant, install temporary battens to facilitate roof loading. Care shall be taken to protect the underlayment during the tile loading and stacking process.

**Job Conditions** – Do not install underlayment over wet surfaces. Ensure other trades are aware and take the necessary precautions when loading materials, roofing and/or stacking of tile is taking place. Any damage that occurs to the underlayment, flashings or battens shall be immediately repaired with like materials.

**Ventilation** – Ventilated or Sealed Attic Systems are required by the building codes. These requirements vary and should be verified by the local jurisdiction. They can be found in Section 1203 of the Florida Building Code and the International Building Code, and in Section R806 of the Florida Residential Code and the International Residential Code. Vents shall comply with ICC-ES AC132 and be installed as per manufacturer's written instructions.

**Warranty** – Refer to specific manufacturer's limited warranty against defects in roof tile.

## PRODUCTS

**DISCLAIMER NOTICE** – The FRSA and TRI Alliance rely on the component industry's data to establish minimum physical properties standards for their products. The standards listed in the products section of this manual reflect that process. Refer to each manufacturer's Product Approval(s) or Compliance Reports for additional information.

**Asphalt** – Shall conform to ASTM D312, Type III or IV (Note slope requirements in the building code).

**Asphalt Plastic Roof Cement** – Conforming to ASTM D4586, Type II, non-asbestos, non-running, heavy-body material composed of asphalt and other mineral ingredients.

**Asphalt Primer** – Conforming to ASTM D41.

**Asphalt Saturated Roofing** – Organic, Type II, commonly called No. 30 or 30#, conforming to a minimum ASTM Standard D226, Type II organic saturated.

**Battens** – Material to be decay resistant exterior grade. Battens should not be bowed or twisted. Horizontal battens shall be a nominal 1" x 2" x 4'. Elevated or counter batten systems require a FBC Product Approval.

**Coatings** – (Optional) Paint shall be color coordinated when painting tile, flashing and/or accessories. Sealer may be used on the point-up mortar. Tint Seal is color coordinated sealer for staining tile or accessories. Refer to Paint or Sealer manufacturer's written application instructions.

**Eave Closure** – Metal, concrete, clay, mortar and raised fascia are all approved.

**Flexible Flashing Products** – Conforming to ICC-ES AC-148 and conform to ASTM D4434, D4637 or D5019.

**Hip and Ridge Metal** – Shall be in compliance with the FBC. Hip and Ridge Metal shall meet the test requirements of SSTD 11-99 and verified by third-party independent FBC approved laboratories.

**Hip and Ridge Plastic Support Structure** – Shall be in compliance with the FBC. Hip and Ridge Plastic Support Structure shall meet the test requirements of SSTD 11-99 and verified by third-party independent FBC approved laboratories.

**Mechanically Attached Membrane Assemblies** – Mechanically attached underlayment assemblies shall be tested in accordance with:

- FM 4474 or UL 1897 wind uplift.
- Minimum 90 days UV exposure per product approval.

**Membranes** – Organic Asphalt impregnated cotton membrane, minimum 4" wide. Inorganic Asphalt impregnated fiberglass membrane, minimum 4" wide conforming to ASTM D1668.

**Mineral Surface Roll Roofing** – Shall be a minimum of seventy four pounds per roll commonly called 90#, conforming to ASTM D6380.

**Modified Bitumen Membrane** – Shall conform to ASTM D6162, D6163 or D6164.

**Modified Bitumen Roofing Mastic** – Shall conform to ASTM D3019, Type III.

**Mortar** – Cement shall conform to ASTM C91 Type M. Sand shall meet ASTM C144, uniformly graded; clean and free from organic materials. Lightweight aggregate shall meet ASTM C332. All mortar used to fasten field tiles shall be factory premixed and bagged. Each mortar manufacturer shall have a FBC Product Approval. All mortar used to fasten hips and ridges shall, in addition to having a FBC Product Approval, be tested in accordance with ICC-SSTD 11-99 data substantiating compliance. Job proportioned mixes (job site mortars) may be used for cosmetic purposes and for "weather block" only, conforming to ASTM C270.

**Nailer Boards** – Material to be decay resistant exterior grade.

All fasteners shall be compatible with material used. Contact the fastener manufacturer for additional information. Nailer boards should not be bowed or twisted. Nailer boards shall be a nominal 2" x (sufficient height to satisfy conditions). Stacking of nailer boards will be allowed. Maximum thickness of 2" per additional nailer board. When installing trim tile with foam, stacked nailer boards must be attached 18" on center with approved fasteners.

**Polyurethane Foam Adhesives** – Shall conform to the following specifications:

- Density conforming to ASTM D1622.
- Compressive strength conforming to ASTM D1621.
- Tensile strength conforming to ASTM D1623.
- Water absorption conforming to ASTM D2842.
- Moisture vapor transmission conforming to ASTM E96.
- Dimensional stability conforming to ASTM D2126.
- Closed cell content conforming to ASTM D6226.
- Surface burning characteristics conforming to ASTM E84.
- Fire tests of roof coverings conforming to ASTM E108.

**Rake Fasteners** – For trim tile, fasteners shall be of sufficient length to penetrate a minimum of 3/4" into the substrate or rafter. Nails shall be a minimum 10d nail, 11 gauge. Screws shall be a minimum #8 screw.

**Self-Adhered Membrane** – Self-adhered products shall have a minimum thickness of 40 mils and shall be tested in accordance with:

- FM 4474 or UL 1897 wind uplift.
- Minimum 90 days UV exposure per product approval.

**Sheathing** – Material shall conform to APA-rated sheathing. Refer to building code wind load requirements. Sheathing must be adequate to support the loads involved, but not less than nominal 1" thick lumber or 15/32" thick plywood or other decking material recognized in a code evaluation report or by the local building official.

**Soil Stacks** – Lead for soil stacks shall be minimum 2-1/2 pounds per square foot. Lead weight flashing requirements, follow Lead Association recommendation.

**Structural Bonding Adhesive** – Shall conform to ASTM D3498.

**Tile Fasteners** – Tile fasteners shall be compatible with treated materials.

**Nails** – shall be corrosion resistant meeting a minimum ASTM A641 Class 1 and/or corrosion resistance equal (according to ASTM B117) of sufficient length to penetrate a minimum 3/4” into or through thickness of the deck even when battens are used. Ring shank nails shall be 10d ring shank corrosion resistant steel nails (3” long, 0.283” flat head diameter, 0.121” shank diameter with 18-22 rings per inch). Smooth or screw shank nails to be 10d corrosion resistant steel (3” long, 0.28” flat head diameter, 0.128” screw or 0.121” smooth shank diameter).

**Screws** – Shall be corrosion resistant meeting ASTM A641 Class 1 and/or corrosion resistance equal (according to ASTM B117). Screws shall be of sufficient length to penetrate a minimum of 3/4” into or through the deck even when battens are used. ASTM A641 Class 1 is a nail specification that can be converted to screw fasteners through performance based testing (ASTM B117). Each fastener manufacturer is responsible for supplying this support data. Minimum #8 course thread.

**Tin Tags** – Shall be not less than 1-5/8” or greater than 2” in diameter and a minimum 32 gauge steel sheet metal.

**Underlayment Fasteners** – Nails or Cap Nails shall be of sufficient length to properly penetrate 1” into or through thickness of deck, whichever is less. Minimum 12 gauge.

## UNDERLAYMENT & FLASHINGS MATRIX

**Inspection** – Verify that surfaces to receive the underlayment are uniform, smooth, clean and dry. Proper ventilation is recommended on all tile applications. Verify ventilation requirements as set forth in the governing building code. When exposed ceilings are utilized, special precautions should be used.

**Roof Parameters** – Use the matrix below to determine the type of roof that will be installed. Each parameter is dependent upon the next. Do not mix and match; follow the matrix as it flows from left to right.

Battens Utilized	Pitch of Roof	Field Tile Attachment	Number of Plies	Underlayment Application Method	Metal Flashing Type	Pre-formed Flashings With Returns or Without Returns	Transitional Flashings Required	Roof Tile Fastener Penetrations
Yes	4:12 and Greater	Mechanical or Adhesive	Single	Self-Adhered	Pre-Formed	With Returns	Yes	N/A
			Two	Cold Applied	Pre-Formed	With Returns	Yes	N/A
				Heat Applied	Pre-Formed	With Returns	Yes	N/A
				Hot Mopped	Pre-Formed	With Returns	Yes	N/A
				Self-Adhered	Pre-Formed	With Returns	Yes	N/A
No	4:12 and Greater	Mechanical or Adhesive	Single	Self-Adhered	Pre-Formed	Either	No	See note below
					Roll	Without Returns	No	See note below
			Two	Cold Applied	Pre-Formed	Either	No	Sealed
					Roll	Without Returns	No	Sealed
				Heat Applied	Pre-Formed	Either	No	Sealed
					Roll	Without Returns	No	Sealed
				Hot Mopped	Pre-Formed	Either	No	Sealed
					Roll	Without Returns	No	Sealed
				Self-Adhered	Pre-Formed	Either	No	See note below
					Roll	Without Returns	No	See note below
	3:12 Less than 4:12	Mechanical or Adhesive	Single	Self-Adhered	Pre-Formed	Either	No	Sealed
					Roll	N/A	No	Sealed
			Two	Cold Applied	Pre-Formed	Without Returns	No	Sealed
					Roll	N/A	No	Sealed
				Heat Applied	Pre-Formed	Without Returns	No	Sealed
					Roll	N/A	No	Sealed
				Hot Mopped	Pre-Formed	Without Returns	No	Sealed
					Roll	N/A	No	Sealed
				Self-Adhered	Pre-Formed	Without Returns	No	Sealed
					Roll	N/A	No	Sealed
	2:12 Less than 4:12	Adhesive	Single	Self-Adhered	Pre-Formed	Without Returns	No	Sealed
					Roll	N/A	No	Sealed
			Two	Cold Applied	Pre-Formed	Without Returns	No	Sealed
					Roll	N/A	No	Sealed
Heat Applied				Pre-Formed	Without Returns	No	Sealed	
				Roll	N/A	No	Sealed	
Hot Mopped				Pre-Formed	Without Returns	No	Sealed	
				Roll	N/A	No	Sealed	
Self-Adhered				Pre-Formed	Without Returns	No	Sealed	
				Roll	N/A	No	Sealed	

**Note:** Refer to the underlayment manufacturer's written installation instructions or Product Approval.



## SINGLE-PLY SYSTEM

**General** – Single-ply Systems or One-ply are those methods of application where a self-adhered underlayment is applied directly to the deck. Minimum thickness of any self-adhered underlayment shall be 40 mil SBS, APP or Approved Equal. Valley metal flashing shall be roll or pre-formed. When using battens, pre-formed metals and transitional flashing are required. Flashings that terminate in the field of the roof require transitional flashing.

**Eave Metal** – Prior to installing the eave metal, the deck to receive the eave metal must be primed with a compatible primer or a separator sheet must be installed. When using a separator sheet, attach it to the decking at the eave with nails and tin tags, round cap nails or other fasteners to hold the separator sheet in place until the eave metal is installed. The separator sheet shall extend past the deck flange of the eave metal by a maximum of 2”.

Install the eave metal over the primed substrate or the separator sheet. The eave metal shall be fastened 6” on center with approved fasteners. All joints shall be lapped a minimum of 3” and sealed with compatible flashing cement, beads of sealant or solid coating at the lap. The eave metal shall be coated with compatible primer prior to the underlayment being installed.

Since raised fascia and starter strips create the same type of water dam situation, they both require an anti-ponding system to allow water to flow off the roof at the eave. See Drawing FHW-14.

**Underlayment Application** – Apply the single-ply underlayment sheet perpendicular to the slope of the roof and backnail it to the deck with nails and tin tags, round cap nails or other approved fasteners spaced 12” on center near the top edge of underlayment. Use a minimum 4” headlap unless limited by product design, and 6” end laps. Extend the underlayment sheet a minimum of 4” up vertical surfaces. Overlap hip and ridges a minimum of 6”. Offset end laps a minimum of 1’.

**Valley Intersection** – When using a single-ply underlayment at the valley intersection, choose one of the following installation methods. Be sure that the underlayment does not create a gap due to memory of the material. Incorporate the proper placement of valley metal.

• **Full Weave** – Install underlayment to ensure all valleys are woven past the centerline and through the succeeding course of underlayment on the intersecting deck to prevent a water lap. Ensure that each course of underlayment is overlapped by the succeeding course at the intersecting roof plane. Proceed up the roof to the ridge. See Drawing FHW-04.

• **Center Cut Valley** – Attach a 36” wide self-adhered underlayment of compatible material in the center of the valley. Install the underlayment to ensure the valley material is terminated at the center of the valley on both intersecting decks. Proceed up the roof to the ridge. See drawing FHW-04.

**Gable/Rake** – Once the single-ply underlayment installation is complete, install the gable metal. Choose one of the following:

• **On Top of the Single-Ply** – Secure the gable metal 6” on center with approved fasteners. All joints shall be lapped a minimum of 3” and sealed with compatible flashing cement, beads of sealant or solid coating at the lap. Continue from eave up rake/gable in same manner, ensuring water-shedding capabilities of all metal laps.

Optional Securement: On the gable, the metal and underlayment sheet may be joined with a bed of flashing cement and a 4” strip of asphalt saturated cotton or fiberglass fabric. The fabric shall be fully embedded in the flashing cement. A self-adhered stripping ply of compatible material may be used instead of flashing cement and membrane.

• **Under the Single-Ply** – Prior to installing the gable metal, the deck to receive the gable metal must be primed with a compatible asphaltic primer or a separator sheet must be installed. When using a separator sheet, attach it to the decking at the gable with nails and tin tags, round cap nails or other fasteners to hold the separator sheet in place until the gable metal is installed. The separator sheet shall extend past the deck flange of the gable metal by a maximum of 2”.

• **Wrapped Gable** – Choose one of the following: (Not recommended for flush finish. Rake tiles must be installed.)

• Extend underlayment beyond rake/gable end. Fold down onto fascia or barge board. Secure with nails and tin tags, round cap nails or other fasteners 6” on center.

• Trim underlayment at fascia or barge board. Install a self-adhering underlayment, extending underlayment beyond rake/gable end. Fold down and seal onto fascia or barge board.

## TWO-PLY SYSTEM

**General** – Two-ply Systems are those methods of application where a base sheet is mechanically attached or self-adhered to the decking. The cap sheet shall be attached by hot asphalt, cold process, heat applied or self-adhered. Minimum thickness shall be 40 mil SBS, APP or approved equal.

**Base Sheet** – The base sheet shall be self-adhered or mechanically attached to the deck with nails and tin tags, round cap nails or other approved fasteners spaced in accordance with the underlayment manufacturer's recommendations and product approval. Self-adhered base sheets shall be installed per manufacturer's instructions. Extend the base sheet a minimum of 4" up vertical surfaces. Base sheet end laps shall be a minimum of 6" and headlaps shall be a minimum of 4". Install the base sheet to ensure all valleys are woven past the centerline and through the succeeding course of underlayment on the intersecting deck to prevent a water lap. Ensure that each course of underlayment is overlapped by the succeeding course at the intersecting roof plane. Proceed up the roof to the ridge. Overlap hip and ridges a minimum of 6". Offset end laps a minimum of 1'.

**Drip Edge** – The eave and gable drip edge metal shall be installed over the base sheet. The metal shall be coated with compatible primer prior to the cap sheet being installed. The metal shall be fastened 6" on center with approved fasteners. All joints shall be lapped a minimum of 3" and sealed with compatible flashing cement, beads of sealant or solid coating at the lap. Continue from eave up the rake/gable in the same manner, ensuring water-shedding capabilities of all metal laps.

Since raised fascia and nailer create a water dam situation, they require an anti-ponding system to allow water to flow off the roof at the eave. See Drawing FHW-14.

**Cap Sheet** – The Two-ply underlayment flashing option determines the cap sheet installation timing. Choose one of the following and proceed accordingly:

- Under the Cap Sheet. See Metal Installation. See Drawings FHW-01 and FHW-02.
- On Top of the Cap Sheet. Proceed to the next section. See Drawings FHW-01 and FHW-02.

**Cap Sheet Installation** – End laps shall be a minimum of 6" and headlaps shall be a minimum of 3" and back-nailed 12" on center with approved fasteners. Install cap sheet to ensure all valleys are woven past the centerline and through the succeeding course of cap sheet on the intersecting deck to prevent a water lap. Ensure that each course of cap sheet is overlapped by

the succeeding course at the intersecting roof plane. Overlap all hip and ridges by 6". On cap sheet, cut any fishmouths and seal with flashing cement and membrane where applicable. When using pre-formed metals without edge returns, the cap sheet should terminate 1" from the water diverter to ensure adhesion to the primed metal. Offset end laps a minimum of 1'.

**Cap Sheet Attachment Method** – Choose one of the following:

- **Hot Asphalt** – Install the cap sheet with an application rate of 25 pounds per square  $\pm$  15% mopping of asphalt. The cap sheet may come in contact with the base sheet, allowing felt to touch felt.
- **Self-Adhered** – Over installed base sheet, apply one layer of self-adhered underlayment in compliance with the self-adhered underlayment manufacturer's recommendation.
- **Cold Process** – Install cap sheet according to underlayment/adhesive manufacturer's recommendations. For cold process systems in windy conditions, it may be necessary to spot nail cap sheet laps at a maximum of 3' on center.
- **Heat Applied** – Install cap sheet per manufacturer's instructions.

**Valley Intersection** – When installing the cap sheet at the valley intersection, choose one of the following installation methods. Be sure that the underlayment does not create a gap due to memory of the material. Incorporate the proper placement of valley metal.

- **Full Weave** – Install underlayment to ensure all valleys are woven past the centerline and through the succeeding course of underlayment on the intersecting deck to prevent a water lap. Ensure that each course of underlayment is overlapped by the succeeding course at the intersecting roof plane. Proceed up the roof to the intersecting roof plane. Proceed up the roof to the ridge. See Drawing FHW-04.
- **Center Cut Valley** – Attach a 36" wide sheet of compatible material in the center of the valley. Install the underlayment to ensure the valley material is terminated at the center of the valley on both intersecting decks. Proceed up the roof to the ridge. See Drawing FHW-04.

## METAL FLASHINGS

**General** – Each roof parameter is unique and requires that the proper metals be used with the correct combination of roof parameters. **Do not interchange metal options.**

**Transitional Flashings** – When battens are used, transitional flashings are required. Install flexible flashings at all valley, ridge and wall transitions. Turn up a minimum of 1" to create a water diverter, ensuring water-shedding capabilities. See Drawing FHW-07.

**Single-Ply System** – Pre-formed metals with edge returns shall be installed on top of the single-ply underlayment and secured with clips. Pre-formed metals without edge returns and roll metal flashing shall be stripped in or sandwiched between a separator sheet and the self-adhered underlayment. Transitional flashings are required when battens are utilized. See Drawing FHW-07.

**Two-Ply System** – Pre-formed metals with edge returns shall be installed on top of the cap sheet and secured with clips. Pre-formed metals without edge returns and roll metal flashing shall be stripped in or sandwiched between the base sheet and the cap sheet. Transitional metals are required when battens are utilized.

**Metal Flashings Installation** – All metal surfaces that the underlayment adheres to must be primed with a compatible primer.

If the metal is to be installed under a single-ply underlayment then, prior to installing the metal, a separator sheet must be installed. When using a separator sheet, attach it to the deck with nails and tin tags, round cap nails or other fasteners to hold the separator sheet in place until the metal is installed. Install the metal over the separator sheet.

All metal flashings without edge returns shall be fastened 6" on center with minimum 12 gauge corrosion resistant roofing nails, or other approved fasteners of compatible metals near the outside edge of the metal. All joints shall be lapped a minimum of 6" and set in a bed of compatible flashing cement, beads of sealant or solid coating at the lap. See Drawing FHW-05.

**Valleys** – Start at the lower portion of the roof and work up to ensure water-shedding capabilities. Where special conditions exist, it may be necessary to increase the width of the valley flashing. The entire width of the valley flashing shall overlap the drip edge. The center of valley flashing shall extend a minimum of 2" beyond drip edge. When battens are used, install transitional flashings or flexible flashing at all valley, ridge and wall transitions. Turn up a minimum of 1" to create a water diverter, ensuring water-shedding capabilities onto the valley. See Drawing FHW-07. Incorporate the proper placement of valley metal.

Choose one of the following valley metals: (See Drawing FHW-05.)

• **Pre-Formed Metals with Edge Returns** – Select Open or Closed Valley.

• **Open** – Valley metal shall be a minimum of 16" (24" stretch-out) with a minimum 1" high center diverter and minimum 1" metal edge returns. See Drawing FHW-06.

• **Closed** – Valley metal shall be a minimum width of 16" (24" stretch-out) with a minimum 2-1/2" high center diverter and a minimum 1" metal edge returns. See Drawing FHW-06.

When using valley metal with edge returns, do not close or deform edge returns. Secure with clips fabricated from similar or compatible material. Clip the 1" metal edge returns to the deck a maximum of 16" on center or at each tile course with approved fasteners. Trim metal at all valley/ridge junctions, ensuring water-shedding capabilities onto the valley. Do not penetrate the roof flange inside of the returns except with properly sealed fasteners at the metal headlaps.

• **Pre-Formed Metals without Edge Returns** – Select Open or Closed Valley.

• **Open** – Valley metal shall be a minimum of 16" (24" stretch-out) with a minimum 1" high twin center diverter. See Drawing FHW-06.

• **Closed** – Valley metal shall be a minimum width of 16" (24" stretch-out) with a minimum 2-1/2" high center diverter. See Drawing FHW-06.

• **Pre-Formed Metals with Ribbed Water Diverters without Edge Returns** – Select Open or Closed Valley.

- **Open** – Valley shall be a minimum 1-1/2" high twin center diverter spaced 6" apart from each other and two ribbed water diverters designed with a minimum 3/8" ribs spaced 3" from the adjacent diverter and 3" apart from each rib with a 3-1/4" outside flange for terminating the metal to the underlayment. See Drawing FHW-05.
- **Closed** – Valley metal shall be a minimum 1-1/2" high center diverter and four ribbed water diverters designed with minimum 3/8" ribs spaced at least 3" from the center diverter and at least 3" apart from each rib with a minimum 2-1/2" outside flange for terminating the metal to the underlayment. See Drawing FHW-05.

Valley metal nailing flange shall be primed with compatible primer up to the outside diverter. The metal flange and the cap sheet shall be joined with hot asphalt or a bed of flashing cement and a 4" strip of asphalt saturated cotton or fiberglass fabric. The fabric shall be fully embedded in the flashing cement. When the valley metal is installed on top of the cap sheet, a self-adhered stripping ply of compatible material may be used instead of flashing cement and membrane.

- **Standard Rolled Valley Metal** – Rolled valley shall be a minimum 16" wide. When the valley metal is to be installed under the cap sheet, the valley metal shall be primed with compatible primer and the cap sheet shall be joined with hot asphalt. When the valley metal is installed on top of the cap sheet, the metal and cap sheet shall be joined with a bed of flashing cement and a 4" strip of asphalt saturated cotton or fiberglass fabric. The fabric shall be fully embedded in the flashing cement. When the valley metal is installed on top of the cap sheet, a self-adhered stripping ply of compatible material may be used instead of flashing cement and membrane. See Drawings FHW-05 and FHW-08.

**Wall Flashing** – Start at lower portion and work up to ensure water-shedding capabilities. Both vertical and horizontal flange shall be terminated with a bed of flashing cement and a 4" strip of asphalt saturated cotton or fiberglass fabric at the edge of the flange. The fabric shall be fully embedded in the flashing cement. If flashing cement is not used, a self-adhered stripping ply of compatible material may be used instead of the

flashing cement and membrane for the termination of the vertical flange to the wall substrate.

When a wall flashing terminates at the eave, the wall metal should extend past the eave a minimum of 1" and be cut to divert water away from the wall. See Drawings FHW-09 and FHW-12. The water diverter (sometimes referred to as a "kicker") is cut into the pan of the wall metal and tucked under the pan to create the water diverter. All water diverters shall be set in a bed of compatible flashing cement, beads of sealant or solid coating. Where special conditions exist, it may be necessary to increase the width and/or the height of the wall metal. In all cases, flashing shall be designed to adequately direct water flow. Choose one of the following:

- **Pre-Formed Metal with Edge Returns** – The wall metal flashing shall be a minimum of 5" x 6" "L" flashing with a minimum 1" metal edge return (12" stretch out). When using wall flashing with edge returns, secure with clips fabricated from similar or compatible metal. Clip the 1" metal edge returns to the deck a maximum of 16" on center. Do not close or deform edge returns.
- **Pre-Formed Metals with Two Water Diverter Ribs without Edge Returns** – The wall metal shall be a minimum 5" x 6" "L" flashing with two 3/8" diverter ribs spaced 2" from vertical wall flange with ribs spaced a minimum 1-1/2" apart and a 2" nailing flange (12" stretch out). When the wall metal is concealed under cap sheet, the metal shall be primed with compatible primer and the cap sheet shall be bonded to the metal. When the wall metal is installed on top of the cap sheet, the wall metal and cap sheet shall be joined with a bed of flashing cement and a 4" strip of asphalt saturated cotton or fiberglass fabric. The fabric shall be fully embedded in the flashing cement. When the wall metal is installed on top of the cap sheet, a self-adhered stripping ply of compatible material may be used instead of flashing cement and membrane. See Drawings FHW-11 and FHW-12.
- **Metal Wall Flashing without Returns** – The wall metal shall be a minimum of 4" x 4" "L" flashing. When the wall metal is concealed under cap sheet, the metal shall be primed with compatible primer and the cap sheet shall be bonded to the metal. When the wall metal is installed on top of the cap sheet, the metal and cap sheet shall be joined with a bed

of flashing cement and a 4" strip of asphalt saturated cotton or fiberglass fabric. The fabric shall be fully embedded in the flashing cement. When the wall metal is installed on top of the cap sheet, a self-adhered stripping ply of compatible material may be used instead of flashing cement and membrane. See Drawings FHW-09 and FHW-10.

**Optional Counter Flashings at Wall Abutments –**

When installing optional counter flashing, lap top flange of wall flashing a minimum of 2-1/2". Lap joints a minimum of 6" and apply flashing cement, beads of sealant, solid coating or separator sheet between the laps. Mechanically fasten counter flashing near the outside edge a minimum of 6" on center or set counter flashing into reglets and seal thoroughly. The metal and vertical flange support shall be joined with a bed of flashing cement and a 4" strip of asphalt saturated cotton or fiberglass fabric. The fabric shall be fully embedded in the flashing cement. If flashing cement is not used, a self-adhered stripping ply of compatible material may be used instead of the flashing cement and membrane; metal surfaces to be primed with compatible primer. On framed walls, a vapor barrier may be installed by others over the vertical flange.

**Curb Mounted Skylights, Chimneys, Etc. –** Install in compliance with regular flashing installation procedures. For self-curbing or prefabricated skylights, refer to skylight manufacturer's installation instructions.

**Soil Pipes, Vents, Etc. –** When applying directly to the deck, apply flashing cement around base of the protrusion and on the bottom side of metal flanges, sealing unit base flashing to deck. Nail and secure all sides of base flashing flanges near the edge. Make certain base is flush to deck. If pipes, vents and/or turbines are installed after finished cap sheet, then the cap sheet and metal flange shall be joined with a bed of flashing cement and a 4" strip of asphalt saturated cotton or fiberglass fabric. The fabric shall be fully embedded in the flashing cement. If flashing cement is not used, a self-adhered stripping ply of compatible material may be used instead of the flashing cement and membrane; metal surfaces to be primed with compatible primer. Profile specific ventilators should be installed per manufacturer's installation instructions. Pipes, vents and stacks shall terminate a minimum 2" above uppermost adjacent finished tile surface. See Drawings FHW-20 and FHW-21.

**Attic Ventilators –** Shall be installed per manufacturer's installation instructions.

## TILE INSTALLATION

**Layout Horizontal** – Chalk horizontal lines beginning one tile length from eave less desired overhang. Overhang shall be 3/4" to 2" depending on tile type, use of a gutter or other functional requirements. All roof tile installations shall have a minimum 3" headlap unless restricted by product design. When battens are used, the top course should be held down approximately 1-1/2" from the ridge frame.

**Layout Vertical** – Choose one of the following:

- **Staggered/Cross Bond Tile Installation.**

**Gable Roofs** – When using rake tile, chalk vertical lines the width of one full tile plus the desired stagger and an additional 1" to 2" from starting gable to accommodate the rake tile. When using a flush finish (point up), chalk vertical lines the width of one full tile plus the desired stagger and an additional 1/4" from starting gable to accommodate flush finish. Chalk additional lines if necessary to maintain alignment.

**Hip Roofs** – Chalk vertical line 90 degrees from eave line. Chalk second line parallel to first to accommodate staggered/cross bonded tile. Chalk additional lines if necessary to maintain alignment.

- **Straight Bond Tile Installation** – Not recommended for flat/low profile tile.

**Gable Roofs** – When using rake tile, chalk vertical lines one full tile width plus 1" to 2" from starting gable to accommodate the rake tile. When using a flush finish (point up), chalk vertical lines one full tile width plus 1/4" from starting gable to accommodate flush finish. Chalk additional lines if necessary to maintain alignment.

**Hip Roofs** – Chalk vertical line 90 degrees from eave line. Chalk second line parallel to first to accommodate straight bond tile. Chalk additional lines if necessary to maintain alignment.

**Batten Installation** – Horizontal battens shall be a maximum of 4' in length. The batten material may be longer in length provided there are 1/2" weep holes every 4'. Battens are optional for 4:12 pitch and above. Install top edge of horizontal batten to horizontal line.

Horizontal battens to be a minimum nominal 1" x 2". Batten shall be fastened and secured a maximum 24" on center with fasteners of sufficient length to penetrate the sheathing a minimum 3/4" or through the thickness of the sheathing.

If utilizing staples, then the battens shall be attached at 12" on center with staples 7/16" crown, No.16 gauge corrosion resistant allowing for 3/4" penetration into roof deck or through the sheathing whichever is less. Staples cannot be used with adhesive set systems.

Leave 1/2" space between batten ends and between batten and metal edge returns. Fasteners shall be compatible with batten material.

**Note:** Elevated or counter batten systems require FBC Product Approval. Contact the roof tile manufacturer for Product Approval and installation instructions.

**Tile Installation** – Stack tile to facilitate installation and minimize tile movement. See Drawing FHW-27. Choose one of the following eave closures:

- **Metal Eave Closure** – Install closure strip along eave. Fasten minimum 18" on center. If metal closure is inclusive of the drip edge, fasten 6" on center. See Drawing FHW-14.
- **Prefabricated Rubber Eave Closure** – Install closure strip along eave. Fasten with minimum three fasteners per 36" strip. See Drawing FHW-14.
- **Raised Fascia/Wood Starter Strip** – See Drawing FHW-14.
- **Prefabricated Concrete or Clay Eave Closure** – Apply per manufacturer's instructions.
- **Mortar** – Install mortar to elevate eave tile on granular surfaced underlayments only. Apply mortar along the eave edge, applying enough mortar to elevate the eave end of the tile to be on plane with the remaining roof tile. Point and smooth finish flush to eave line. A minimum 3/8" weep hole flush with the roof underlayment shall be formed at the spacing of not less than one weep hole per tile.

### Fastening Options for Adhesive Set Tile Installations

For roof slopes 2:12 up to and including 6:12, fasteners are not required in addition to the adhesives.

For roof slopes greater than 6:12, and up to and including 7:12, fasten every tile in the first course and every third tile every fifth course in addition to the adhesive, preferably in through the nail hole closest to overlock of tile being fastened.

For roof slopes greater than 7:12, fasten every tile in addition to the adhesive, preferably through the nail hole closest to overlock of tile being fastened.

When utilizing battens and tiles with protruding anchor lugs, fastening is not required in addition to the adhesive.

**Note:** Foam applied systems require FBC Product Approval. Refer to the roof tile foam adhesive manufacturer for Product Approval and installation instructions.

**Flat/Low, Medium and High Profile Tile** – Tile shall be attached to resist the aerodynamic moment as determined when using the design pressures for the building and the attachment calculations set forth in the local building code.

Starting at the eave, make certain the tile overhangs the drip edge uniformly along the first course. The tile shall overhang the eave line by at least 3/4" but not more than 2". Secure tiles with nails, screws, foam/adhesive or mortar. For allowable uplift resistance of mechanically-attached tile, see Table 3.

Cut/break tile for proper staggering of tile courses when using staggered/cross bond method of installation. Set tile in stepped course fashion or in a horizontal and/or vertical fashion when utilizing straight bond method. Lay succeeding courses of field tile in same manner. Cut/break field tile to form straight edge at center of hip/ridge.

**Valleys** – It is not recommended to install trim tile in the valleys. It may be necessary to remove the lugs from the field tile at walls and valley flashings for proper positioning of cut field tiles. Choose one of the following:

- **Valley Metal without Water Diverters.**

- **Closed Valley** – Miter tile to meet at center of valley. See Drawing FHW-06.

- **Open Valley** – Chalk a line minimum 2" on both sides of valley center. Place bed of mortar along outside edge of chalk lines on granular surfaced underlayments only. Miter tile to form straight border and point mortar to finish. See Drawing FHW-06.

- **Valley Metal with Water Diverters.**

- **Closed Valley** – Miter tile to form straight border on either side of water diverters. See Drawing FHW-06.

- **Open Valley** – Miter tile to form straight border on either side of the two water diverters. See Drawing FHW-06.

**HIP AND RIDGE INSTALLATION**

**General** – The following recommendations are only for products approved by the FBC and tested according to SSTD 11-99 via third-party independent FBC approved laboratories. They will determine the wind uplift limitations of the various hip and ridge attachment methods or by installation methods currently recognized in the High Velocity Hurricane Zone (HVHZ) section of the FBC. There are three basic attachment methods of hip and ridge tiles: mechanical attachment, adhesive-set and mortar-set attachment systems. The minimum headlap when installing hip and ridge tiles is 2” unless restricted by product design. Any exposed fasteners should be covered with a UV resistant sealant.

**Field Tile Cuts at Hip or Ridge** – All cut field tiles adjacent to a hip or ridge shall be attached to the cap sheet and/or the adjacent tile with an approved adhesive, mortar or mechanical fasteners and adhesive.

The following table outlines the different parameters for the hip and ridge attachment options. See Drawings FHW-15, FHW-16 and FHW-17.

**HIP AND RIDGE ATTACHMENT TABLE**

Field Tile Attachment	Structural Support	Member Attachment	Trim Tile Attachment	Weatherblocking	Finish
Foam Mechanical Mortar	Metal	Mechanical or Foam	Foam	Foam	Coating
				Mortar	Mortar
	Plastic	Foam	Foam	Foam	Coating
				Mortar	Mortar
				Foam	Coating
	Wood	Foam H-Bracket Straps	Foam	Mortar	Mortar
				Mortar	Mortar
			Mechanical with Adhesive	Foam	Coating
				Flexible	Dry
Mortar	Mortar	Mortar	Mortar	Mortar	
			Mortar	Mortar	

**Hip and Ridge Attachment** – Choose one of the following:

- **Metal Member** – Seal all nail penetrations with compatible roof cement unless the underlayment meets ASTM D-1970 Sec. 7.9. Fasten 6” on center on each side of the metal flange with minimum 1-1/4” ring shank roofing nails. If mechanical attachment of the member is not used, install the member with foam per the manufacturer’s instructions.
- **Plastic Member** – Install the member with foam per the manufacturer’s instructions.
- **Wood Member** – Fasten 18” on center with four #8 screws per metal strap or H-bracket. Each attachment point shall have two fasteners on each side of the wood member. The fasteners shall be spaced evenly on the metal strap or H-bracket with

the attachment holes parallel to the hip or ridge. The straps and H-brackets shall be a minimum of 26 gauge. All materials must be compatible with each other. If mechanical attachment of the wood member is not used, install the member with foam per the manufacturer’s instructions. Seal all nail penetrations with compatible roof cement unless the underlayment meets ASTM D-1970 Sec. 7.9.

- **Mortar** – When using foam or mortar field tile attachment, mortar can be used as a structural attachment. Place a full bed of pre-bagged mortar under the entire tile. Each tile must be fully embedded into the mortar. The field tile secured to the underlayment along with the mortar on each trim tile creates the structural bond. The entire cavity under the trim tile should be filled with approved mortar. See Drawing FHW-18.



**Starter Tiles** – All starter tiles must be secured at both ends of the tile either with mechanical fasteners, mortar and/or adhesive.

When the field tile is installed with foam or mortar, the starter tile may be installed with an approved mortar.

If using a structural member, choose one of the following:

- **Metal Member** – Place foam under starter tile per manufacturer's recommendations or secure the head of the tile with one #8 screw and apply adhesive in the gap between the structural support and the tile. The member may need to be cantilevered to provide a base for the adhesive. The starter tile must make contact with the adhesive. See manufacturer's recommendations.
- **Plastic Member** – Place foam under starter tile per manufacturer's recommendations.
- **Wood Member** – Place foam under starter tile per manufacturer's recommendations or drill a hole in the lower third of the starter tile and secure with a mechanical fastener into the wood member a minimum of 1". Seal the head of the fastener with a UV-resistant sealant. Adhesive may be used in lieu of a fastener as long as the wood member has been cantilevered to provide a base for the adhesive. The adhesive between the structural support and the tile must make continuous contact with both the structural support and the tile. See manufacturer's recommendations.

Miter or point up the hip starter tile to match the intersecting eaves.

**After the Starter Tile** – Install the next tile centering over the structural support and/or the starter tile. Continue in same manner working from the lowest point toward the highest point of the roof. At intersecting junctions (i.e., hip/ridge, ridge/gable, ridge/valley), cut tile to form a solid fit and ensure the first and the last hip/ridge tile is securely fastened. Any exposed fasteners shall be sealed with a UV-resistant sealant. Foam must come in contact with the bottom of the tile and structural support member.

**Weather Blocking** – Hip and ridge tiles need to have weather blocking. Choose one of the following. See Drawing FHW-16 for more details.

- **Mortar** – Pre-bagged or job-site mix is used to weather block the longitudinal edges of the hip and ridge tiles and provide aesthetics. A full bed of mortar is placed along the longitudinal edges of the hip and ridge tile either during the application of the hip and ridge tiles or may be packed in after the hip and ridge tiles are installed and the adhesive has cured. Install mortar to seal all voids between the field tile and the hip/ridge tile. Care should be taken to ensure enough mortar is used. The mortar should create a wedge to keep the mortar from dislodging from under the hip/ridge and the field tile junction. Ensure areas are sealed to prevent water entry. After the mortar is packed into place, then apply point up mortar to the desired finish.
- **Foam** – Is used to weather block the entire cavity of the adjoining planes of field tile to the sides of the structural support. This system uses foam as the weather blocking. There is no mortar placed along the longitudinal edges of the hip and ridge tile. Foam is placed where the field tile abuts the structural support. A bead of foam is placed parallel to the hip and/or ridge and the structural support to tile junction to act as a weather block and is applied prior to the attachment of the hip and ridge tile. Install foam to seal all voids between the field tile and the structural support. Care should be taken to ensure all areas are sealed with adhesive to prevent water entry. Apply a polyurethane compatible coating to protect the foam from UV exposure.
- **Flexible Self-Adhered Membrane** – This system can be used with a wood structural support. The flexible self-adhered membrane is applied in a continuous or step fashion, sealing to both sides of the adjoining field tile a minimum of 2" prior to the mechanical attachment of the trim tile to the wood structural support. The flexible flashing may be visible, but should not extend onto the field tile beyond the outside edges of trim tile.

## RAKE/GABLE AND OTHER CONDITIONS

**Rake/Gable** – Choose one of the following:

- **Rake Tile** – Cut and install first rake tile the exposed length of first course of field tile with factory finish of rake tile towards the eave. Fasten rake tile with a minimum two 10d nails of sufficient length to penetrate the framing a minimum of 3/4". Abut each succeeding rake tile to the nose of the field tile above and maintain a constant headlap. See Drawing FHW-19.

- **Mortar Finish** – Place mortar bed along roof edge. Point smooth to a straight edge finish.

**Wall Abutments** – It may be necessary to remove lugs from the field tile and/or install batten extenders at wall flashing for proper positioning of cut field tiles. For mechanically attached tile systems, tiles installed at wall abutment shall be attached with an adhesive. The adhesive shall be installed to the underlayment or the tile below/next to the tile being installed to meet the required uplift. Cut the tile to fit within 1" of the base of finished wall. Point-up mortar is optional. See Drawing FHW-12.

**Plumbing Stacks/Soil Stacks** – Choose one of the following:

- **Pre-Formed Soil Flashing (with returns)** – A lead skirt flashing or flexible flashing with minimum 18" x 18" base shall be used. This flashing shall be woven in with the tile coursing. See Drawing FHW-21.

- **Pre-formed Flashing (without returns)** – Cut tile to fit close to plumbing stack; fill void with mortar and point to finish. See Drawing FHW-20.

**Coatings** – (Optional) Sealer may be applied to exposed mortar. Color coordinated paint may be applied to metal flashings.

**Tile Replacement/Damaged Tile** – Break out and replace damaged roof tile. Do not disturb underlayment. Repair underlayment if necessary. The lugs of the tile may need to be removed to position tile. Apply adhesive per adhesive manufacturer's recommendations. Immediately set replacement tile in position assuring proper contact.

**Small Valley and Hip Cuts** – Elevate nose end of tile in course above small cut tile. Apply adhesive per adhesive manufacturer's recommendations. Immediately set tile in course above in a position which assures proper contact. For roof slopes greater than 7:12 on hip cuts only, mechanical fastening may be required.

**Clean Up** – Remove all broken tile, debris and excess tile from roof.

**Miscellaneous Recommendations** – Instructions shall be given to all parties involved cautioning against traffic of any kind on finished roof. Damage to roof tiles and/or sub-roof may result.

## **APPENDICES**

ROOF PROJECT DESIGN FLOW CHART

Underlayment Design

Identify Exposure Category:  
 Identify Mean Roof Height:  
 Identify Basic Windspeed for Project Location:

Use information from above to identify Required Design Pressure for Underlayment System (Table 1H Hip or Table 1G Gable depending on roof design):

Direct Deck or other underlayment system, identify Allowable Design Pressure from FBC Product Approval (Allowable Design Pressure must be equal to or greater than Required Design Pressure identified above):

Tile Design

Identify Proper Table 2	Gable or Hip?		Exposure?
	Table 2	G/H	B/C/D
Example: Hip Roof in Exposure B would be Table 2 HB			

Table 2 \_ \_ \_

Identify Roof Slope:  
 Identify Mean Roof Height:  
 Identify Ultimate Wind Speed for project:

Use Information above to identify Required Uplift Moment for Tile: LPZ

HPZ

Select method of Tile Attachment from Table 3 or Foam Adhesives Manufacturer's Published Values (Allowable Uplift Moment must be equal to or greater than Required Uplift Moment from above):

## DESIGN CONSIDERATIONS FOR HIGH WIND APPLICATIONS UNDER THE ASCE 7-22 REQUIREMENTS

Please refer to the manufacturer's valid code approval for additional wind design details.

The installation requirements in the Table 2 series provide the normal installation guidelines for concrete and clay tile to comply with the Florida Building Code and International Building Code. The installation of tile in the specific regions of the country that are identified by FBC/IBC as subjected to wind speeds in excess of 110 miles per hour ( $V_{asd}$ ), may be required to have additional fastening options not found in Table 3.

The Tile Roofing Industry Alliance (TRI) has derived various uplift resistance values for nail, screws and adhesive fastening systems on Plywood Sheathing. Some of these methods of installation may have limiting factors depending upon wind speed, roof slope and roof height. Please consult with your tile, underlayment and adhesive manufacturers or design professional for additional information about these optional systems for those unique installations.

The following design aids are provided to the roof designer for consideration in determining the required aerodynamic uplift moment for roof tiles for wind applications beyond the prescriptive requirements in the FBC. These tables were developed based on the requirements of ASCE 7-22 for a tile factor of 1.407 ft<sup>3</sup>. The Tile Factor is determined from the following equation:

TF =  $b \cdot L \cdot La$  (ft<sup>3</sup>) where:

$b$  = exposed width (ft)

$L$  = roof tile length (ft)

$La$  =  $0.76 \cdot L$

Or use the tile factor ratio that provides the ratio of the actual tile to the 1.407 (ft<sup>3</sup>) that some manufacturers have in their formal Product Approvals.

Conversion to Nominal Design Wind Speed  $V_{asd}$  from Ultimate Design Wind Speed  $V_{ult}$  shall be converted as  $V_{asd} = V_{ult} \cdot \sqrt{0.6}$  or from the following table; tables were calculated using  $V_{asd}$ .

For SI: 1 mile per hour = 0.44 m/s A linear interpolation is permitted.

From the Florida Building Code, Building 8th Edition Table 1609.3.1.

		Design Wind Speed Conversion (mph)							
$V_{ult}$	110	120	130	140	150	160	170	180	190
$V_{asd}$	85	93	101	108	116	124	132	139	147

EXAMPLE 1

DESIGN OF ATTACHMENT SYSTEM (EXAMPLE FOR ILLUSTRATIVE PURPOSES ONLY)

A building is a low-rise structure in an Exposure C region where the ultimate design wind speed is 170 mph.

The building is a Category II structure. The mean height of the building is 40 feet. The roof is a gable roof with a roof slope of 7:12. The terrain around the building does not abruptly change so as to create any wind speed-up effects due to channeling or shielding. The building is not located on a hill, ridge or escarpment that would cause the wind to speedup. The roof tiles will be flat/low profile concrete roof tiles with a total tile length of 17" and exposed width of 11.07". The roof tiles weigh 9 pounds each. The roof covering is installed direct to deck on solid sheathing.

Calculate the Required Aerodynamic Uplift Moment and use the Allowable Aerodynamic Uplift Resistance.

Risk Category from (ASCE 7-22 -Table 1.5-1D): Velocity pressure:  $q_h = 0.00256 \cdot K_h \cdot K_{zt} \cdot K_e \cdot V^2$

$q_h$  = velocity pressure at height  $z$  (psf)

Velocity Pressure, $q_h$ (psf)									
Mean Roof Height (ft)	Exposure C								
	Ultimate Design Wind Speeds, $V_{ult}$ (mph - 3-second gust)								
	115	120	130	140	150	160	170	180	190
0-15	17.3	18.8	22.1	25.2	29.4	33.4	37.7	42.3	47.1
20	18.3	19.9	23.4	27.1	31.1	35.4	40.0	44.8	49.9
30	19.9	21.7	25.4	29.5	33.9	38.5	43.5	48.8	54.3
40	21.1	23.0	27.0	31.3	35.9	40.9	46.9	51.8	57.7
50	22.1	24.1	28.3	32.8	37.7	42.9	48.4	54.2	60.4
60	23.0	25.0	29.3	34.0	39.1	44.4	50.2	56.2	62.7

Note: The ultimate design wind speeds,  $V_{ult}$ , have been converted to nominal design wind speeds,  $V_{asd}$ , since roof tile

attachments systems are based on test results.

$K_e$  = ground elevation pressure = (ASCE 7-22 Chapter 26.9)

$K_e$  = 1.0 up to 1,000 ft.

$K_{zt}$  = topographic factor:  $K_{zt} = 1.0$  (ASCE 7-22 Chapter 26.8.2)

$K_h$  = Velocity Pressure Coefficient (ASCE-7-22 10-2)

$V$  = basic wind speed (mph) Fig. 26.5-1D (170 mph)

$q_h = 0.00256 \cdot K_h \cdot K_{zt} \cdot K_e \cdot V^2 = 0.00256 (1.04) (1.0) (1.0) (132\text{mph})^2 = 46.38 \text{ psf}$

From table left  $q_h = 46.9 \text{ psf}$

REQUIRED AERODYNAMIC MOMENT,  $M_a$ ; ALLOWABLE

Sample Calculations Aerodynamic Moment,  $M_a$ :  
Maximum Required Aerodynamic Uplift Moment,  $M_a$  (ft-lbf)

GCp for Roof Zones Gable 27° to 45° Wind Area = 10 ft²	
Zone 1	-1.8
Zone 2	-2.0
Zone 3	-2.5

From Table for 27° to 45° Zone 3r GCp = -2.0	
$q_h$ = Velocity pressure at mean roof height $h$ (psf)	$q_h = 46.9 \text{ psf}$
CL = Lift coefficient	CL = 0.2
$b$ = Exposed width (ft)	$b = 0.92 \text{ ft}$
L = Roof tile length (ft)	L = 1.42ft
$L_a$ = Moment arm from the axis of rotation to the point of uplift on the roof tile (ft)	$L_a = 0.76 L \text{ (ft)}$

$M_a = q_h \text{ CL } b \text{ L } L_a [1 - (\text{GCp})]$   
FBC – 1609.5.3

$M_a = q_h \text{ CL } b \text{ L } L_a (1.0 - \text{GC}) = 46.9 \text{ psf } (0.2) (0.92') (1.42') (1.08') (1 - [-2.5]) = 42.89 \text{ ft-lbf}$   
From Table 3, a proper fastening option will be selected that will meet the 42.89 ft-lbf

## EXAMPLE 2

## (EXAMPLE FOR ILLUSTRATIVE PURPOSES ONLY)

The building in Example 2 is the same design requirements as found in Example 1 except the tile factor is now being calculated for a different tile dimension. For this example, a tile with an exposed width of 12" and a total tile length of 17" is being designed for installation.

In Example 1 we determined:

$$Ma = qh CL b L La (1.0-GC) = 46.9 \text{ psf} (0.2) (0.92') (1.42') (1.08') (1 - [-2.5]) = 42.89 \text{ ft-lbf}$$

For this new tile dimension we will calculate the new Ma:

CL = Lift coefficient	CL = 0.2
b = Exposed width (ft)	b = 1.0 ft
L = Roof tile length (ft)	L = 1.42ft
La = Moment arm from the axis of rotation to the point of uplift on the roof tile (ft)	La = 1.08 L (ft)

$$Ma = qh CL b L La (1.0-GC) = 46.9 \text{ psf} (0.2) (1.0') (1.42') (1.08') (1 - [-2.5]) = 50.34 \text{ ft-lbf}$$

From Table 3, a proper fastening option will be selected that will meet the 50.34 ft-lbf

FOR ASCE 7-22 WIND DESIGNS, THE FOLLOWING ROOF ZONE FIGURES ARE INCLUDED AS A REFERENCE TO THE TABLE CALCULATIONS

Figure 1.0 Hip Roof Zone Designations

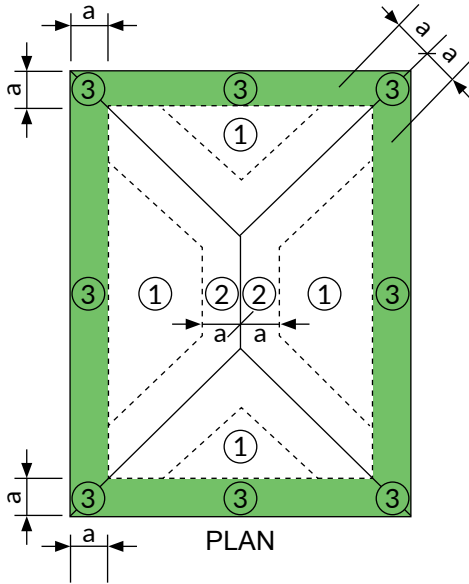

■ = High pressure zone = 3  
 Other = Low pressure zones = 1 & 2

Figure 2.0 Gable Roof Zone Designations

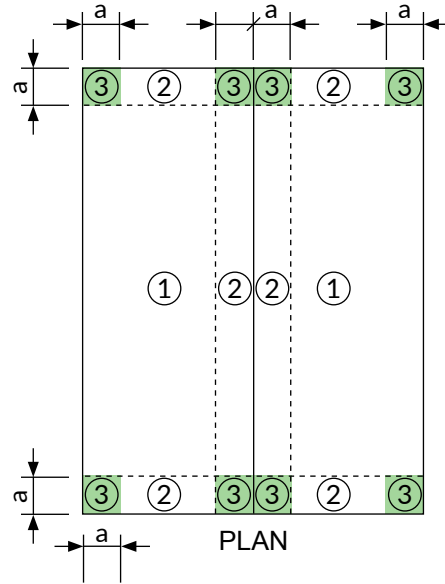

■ = High pressure zone = 3  
 Other = Low pressure zones = 1 & 2

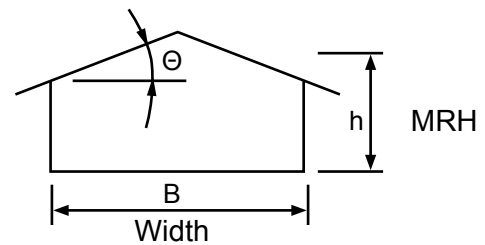
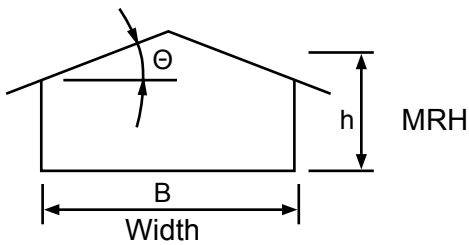

$a = 10\%$  of the width or  $40\%$  of the height, whichever is smaller, but not less than 3 ft.  
 The width (or dimension B), shall not include the overhang.

B = Horizontal dimension of the building in feet.

h = Mean Roof Height (MRH) in feet (eave height plus ridge height divided by 2).

$\Theta$  = Angle of roof plane from horizontal in degrees (slope or pitch).

The roofing professional has the option to review and determine alternative methods that would reflect the full calculation options of ASCE-7-22 that might provide lower uplift resistance values in certain areas.



## DESIGN PRESSURES FOR UNDERLAYMENT AND RIDGE ATTACHMENT REQUIRED FOR CATEGORY II BUILDINGS HAVING A 3:12 AND GREATER PITCH PER ASCE 7-22 (psf)

### TABLE 1H

Hip Roof – ASCE 7-22 (3:12 and Over), Category II Buildings (psf)  
Required Design Uplift Pressures (psf) For Underlayment and Ridge Attachment

Roof Exposure	Roof Zones	Mean Roof Heights	115	120	130	140	150	160	170	180	190
			Design Pressure (psf)	Design Pressure (psf)	Design Pressure (psf)	Design Pressure (psf)	Design Pressure (psf)	Design Pressure (psf)	Design Pressure (psf)	Design Pressure (psf)	Design Pressure (psf)
Exp B	All	0-15	31.4	34.2	40.2	46.6	53.5	60.8	68.7	77.0	85.8
		20	31.4	34.2	40.2	46.6	53.5	60.8	68.7	77.0	85.8
		30	31.4	34.2	40.2	46.6	53.5	60.8	68.7	77.0	85.8
		40	33.2	36.2	42.5	49.2	56.5	64.3	72.6	81.4	90.7
		50	35.5	38.6	45.3	52.6	60.3	68.7	77.5	86.9	96.8
		60	37.3	40.6	47.6	55.2	63.4	72.1	81.4	91.3	101.7
Exp C	All	0-15	38.2	41.5	48.8	56.6	64.9	73.9	83.4	93.5	104.2
		20	40.4	44.0	51.6	59.9	68.7	78.2	88.3	99.0	110.3
		30	44.0	47.9	56.2	65.2	74.9	85.2	96.1	107.8	120.1
		40	46.7	50.8	59.7	69.2	79.4	90.4	102.0	114.4	127.4
		50	48.9	53.3	62.5	72.5	83.3	94.7	106.9	119.9	133.6
		60	50.7	55.2	64.8	75.2	86.3	98.2	110.9	124.3	138.5
Exp D	All	0-15	46.2	50.3	59.1	68.5	78.7	89.5	101.0	113.3	126.2
		20	48.5	52.8	62.0	71.9	82.5	93.9	106.0	118.8	132.3
		30	52.1	56.7	66.5	77.2	88.6	100.8	113.8	127.6	142.2
		40	54.8	59.6	70.0	81.2	93.2	106.0	119.7	134.2	149.5
		50	57.0	62.1	72.9	84.5	97.0	110.4	124.6	139.7	155.6
		60	58.8	64.0	75.2	87.2	100.1	113.8	128.5	144.1	160.5

#### Notes:

1. The pressures (psf) in the above table are indicative of the required design uplift pressure based upon less than 4.5:12 for roof zone 3.
2. The roofing professional has the option to review and determine alternative methods that would reflect the full calculation options of ASCE 7-22 that might provide lower uplift resistance values in certain areas.
3. For actual uplift resistance values for Foam Adhesives or Mortar installations please see the Adhesive manufacturers formal product approvals for additional information.

**DESIGN PRESSURES FOR UNDERLAYMENT AND RIDGE ATTACHMENT REQUIRED FOR CATEGORY II BUILDINGS HAVING A 3:12 AND GREATER PITCH PER ASCE 7-22 (psf)**

**TABLE 1G**

**Gable Roof – ASCE 7-22 (3:12 and Over), Category II Buildings  
Pressures for Underlayment and Ridge Attachment (psf)**

Roof Exposure	Roof Zones	Mean Roof Heights	115	120	130	140	150	160	170	180	190
			Design Pressure (psf)	Design Pressure (psf)	Design Pressure (psf)	Design Pressure (psf)	Design Pressure (psf)	Design Pressure (psf)	Design Pressure (psf)	Design Pressure (psf)	Design Pressure (psf)
Exp B	All	0-15	43.5	47.4	55.6	64.5	74.0	84.2	95.1	106.6	118.8
		20	43.5	47.4	55.6	64.5	74.0	84.2	95.1	106.6	118.8
		30	43.5	47.4	55.6	64.5	74.0	84.2	95.1	106.6	118.8
		40	46.0	50.1	58.8	68.2	78.3	89.0	100.5	112.7	125.6
		50	49.1	53.5	62.8	72.8	83.5	95.1	107.3	120.3	134.0
		60	51.6	56.2	65.9	76.5	87.8	99.9	112.7	126.4	140.8
Exp C	All	0-15	52.8	57.5	67.5	78.3	89.9	102.3	115.5	129.4	144.2
		20	52.8	60.9	71.5	82.9	95.2	108.3	122.3	137.1	152.7
		30	60.9	66.3	77.8	90.3	103.6	117.9	133.1	149.2	166.3
		40	64.6	70.4	82.6	95.8	110.0	125.1	141.3	158.4	176.5
		50	67.8	73.8	86.6	100.4	115.3	131.2	148.1	166.0	184.9
		60	70.2	76.5	89.8	104.1	119.5	136.0	153.5	172.1	191.7
Exp D	All	0-15	64.0	69.7	81.8	94.9	108.9	123.9	139.9	156.9	174.8
		20	67.1	73.1	85.8	99.5	114.2	130.0	146.7	164.5	183.2
		30	72.1	78.5	92.1	106.9	122.7	139.6	157.6	176.7	196.8
		40	75.8	82.6	96.9	112.4	129.0	146.8	165.7	185.8	207.0
		50	78.9	86.0	100.9	117.0	134.3	152.8	172.5	193.4	215.5
		60	81.4	88.7	104.1	120.7	138.5	157.6	177.9	199.5	222.3

## Notes:

1. The pressures (psf) in the above table are indicative of the required design uplift pressure based upon less than 4.5:12 for roof zone 3.
2. The roofing professional has the option to review and determine alternative methods that would reflect the full calculation options of ASCE 7-22 that might provide lower uplift resistance values in certain areas.
3. For actual uplift resistance values for Foam Adhesives or Mortar installations please see the Adhesive manufacturers formal product approvals for additional information.

**TABLE 2 HB**  
**Hip Roof – ASCE 7-22**  
**Exposure B – Tile Factor = 1.407 ft<sup>3</sup>**

Roof Slopes	Mean Roof Heights (ft)	Roof Zones	115	120	130	140	150	160	170	180	190
			Ma (ft-lbf)	Ma (ft-lbf)	Ma (ft-lbf)	Ma (ft-lbf)	Ma (ft-lbf)	Ma (ft-lbf)	Ma (ft-lbf)	Ma (ft-lbf)	Ma (ft-lbf)
Less than 4.5:12	0-30	LPZ	13.6	14.8	17.4	20.2	23.1	26.3	29.7	33.3	37.1
		HPZ	14.4	15.7	18.4	21.3	24.5	27.9	31.5	35.3	39.3
	40	LPZ	14.4	15.7	18.4	21.3	24.5	27.8	31.4	35.2	39.3
		HPZ	15.2	16.6	19.5	22.6	25.9	29.5	33.3	37.3	41.6
	50	LPZ	15.4	16.7	19.6	22.8	26.1	29.7	33.6	37.6	41.9
		HPZ	16.3	17.7	20.8	24.1	27.7	31.5	35.5	39.8	44.4
	60	LPZ	16.1	17.6	20.6	23.9	27.4	31.2	35.3	39.5	44.0
		HPZ	17.1	18.6	21.8	25.3	29.1	33.1	37.3	41.8	46.6
4.5:12 to less than 6:12	0-30	LPZ	12.0	13.1	15.3	17.8	20.4	23.2	26.2	29.4	32.8
		HPZ	12.0	13.1	15.3	17.8	20.4	23.2	26.2	29.4	32.8
	40	LPZ	12.7	13.8	16.2	18.8	21.6	24.6	27.7	31.1	34.6
		HPZ	12.7	13.8	16.2	18.8	21.6	24.6	27.7	31.1	34.6
	50	LPZ	13.5	14.8	17.3	20.1	23.0	26.2	29.6	33.2	37.0
		HPZ	13.5	14.8	17.3	20.1	23.0	26.2	29.6	33.2	37.0
	60	LPZ	14.2	15.5	18.2	21.1	24.2	27.6	31.1	34.9	38.9
		HPZ	14.2	15.5	18.2	21.1	24.2	27.6	31.1	34.9	38.9
6:12 to 12:12	0-30	LPZ	11.2	12.2	14.3	16.6	19.1	21.7	24.5	27.4	30.6
		HPZ	13.6	14.8	17.4	20.2	23.1	26.3	29.7	33.3	37.1
	40	LPZ	11.8	12.9	15.1	17.6	20.2	22.9	25.9	29.0	32.3
		HPZ	14.4	15.7	18.4	21.3	24.5	27.8	31.4	35.2	39.3
	50	LPZ	12.6	13.8	16.2	18.7	21.5	24.5	27.6	31.0	34.5
		HPZ	15.4	16.7	19.6	22.8	26.1	29.7	33.6	37.6	41.9
	60	LPZ	13.3	14.5	17.0	19.7	22.6	25.7	29.0	32.5	36.3
		HPZ	16.1	17.6	20.6	23.9	27.4	31.2	35.3	39.5	44.0

LPZ – Low Pressure Zone 2 for Hip Roofs. HPZ – High Pressure Zone 3 for Hip Roofs.

Wind speeds are V<sub>ult</sub>. Refer to the tile manufacturer for additional information.

See Figures 1.0 & 2.0 on page 22 for additional details on roof zone designations.

**TABLE 2 HC**  
**Hip Roof – ASCE 7-22**  
**Exposure C – Tile Factor = 1.407 ft<sup>3</sup>**

Roof Slopes	Mean Roof Heights (ft)	Roof Zones	115	120	130	140	150	160	170	180	190
			Ma (ft-lbf)	Ma (ft-lbf)	Ma (ft-lbf)	Ma (ft-lbf)	Ma (ft-lbf)	Ma (ft-lbf)	Ma (ft-lbf)	Ma (ft-lbf)	Ma (ft-lbf)
Less than 4.5:12	0-15	LPZ	16.5	18.0	21.1	24.5	28.1	32.0	36.1	40.5	45.1
		HPZ	17.5	19.0	22.4	25.9	29.8	33.9	38.2	42.9	47.7
	20	LPZ	17.5	19.0	22.4	25.9	29.8	33.9	38.2	42.9	47.7
		HPZ	18.5	20.2	23.7	27.4	31.5	35.9	40.5	45.4	50.6
	30	LPZ	19.0	20.7	24.3	28.2	32.4	36.9	41.6	46.7	52.0
		HPZ	20.2	22.0	25.8	29.9	34.3	39.0	44.1	49.4	55.1
	40	LPZ	20.2	22.0	25.8	30.0	34.4	39.1	44.2	49.5	55.2
		HPZ	21.4	23.3	27.4	31.7	36.4	41.4	46.8	52.4	58.4
	50	LPZ	21.2	23.1	27.1	31.4	36.0	41.0	46.3	51.9	57.8
		HPZ	22.4	24.4	28.7	33.2	38.2	43.4	49.0	55.0	61.2
	60	LPZ	22.0	23.9	28.1	32.5	37.4	42.5	48.0	53.8	60.0
		HPZ	23.3	25.3	29.7	34.5	39.6	45.0	50.8	57.0	63.5
4.5:12 to less than 6:12	0-15	LPZ	14.6	15.9	18.6	21.6	24.8	28.2	31.9	35.7	39.8
		HPZ	14.6	15.9	18.6	21.6	24.8	28.2	31.9	35.7	39.8
	20	LPZ	15.4	16.8	19.7	22.9	26.3	29.9	33.7	37.8	42.1
		HPZ	15.4	16.8	19.7	22.9	26.3	29.9	33.7	37.8	42.1
	30	LPZ	16.8	18.3	21.5	24.9	28.6	32.5	36.7	41.2	45.9
		HPZ	16.8	18.3	21.5	24.9	28.6	32.5	36.7	41.2	45.9
	40	LPZ	17.8	19.4	22.8	26.4	30.3	34.5	39.0	43.7	48.7
		HPZ	17.8	19.4	22.8	26.4	30.3	34.5	39.0	43.7	48.7
	50	LPZ	18.7	21.1	23.9	27.7	31.8	36.2	40.8	45.8	51.0
		HPZ	18.7	21.1	23.9	27.7	31.8	36.2	40.8	45.8	51.0
	60	LPZ	19.4	21.1	24.8	28.7	33.0	37.5	42.3	47.5	52.9
		HPZ	19.4	21.1	24.8	28.7	33.0	37.5	42.3	47.5	52.9
6:12 to 12:12	0-15	LPZ	13.6	14.8	17.4	20.2	23.1	26.3	29.7	33.3	37.1
		HPZ	16.5	18.0	21.1	24.5	28.1	32.0	36.1	40.5	45.1
	20	LPZ	14.4	15.7	18.4	21.3	24.5	27.9	31.5	35.3	39.3
		HPZ	17.5	19.0	22.4	25.9	29.8	33.9	38.2	42.9	47.7
	30	LPZ	15.7	17.1	20.0	23.2	26.7	30.4	34.3	38.4	42.8
		HPZ	19.0	20.7	24.3	28.2	32.4	36.9	41.6	46.7	52.0
	40	LPZ	16.6	18.1	21.3	24.7	28.3	32.2	36.4	40.8	45.4
		HPZ	20.2	22.0	25.8	30.0	34.4	39.1	44.2	49.5	55.2
	50	LPZ	17.4	19.0	22.3	25.9	29.7	33.8	38.1	42.7	47.6
		HPZ	21.2	23.1	27.1	31.4	36.0	41.0	46.3	51.9	57.8
	60	LPZ	18.1	19.7	23.1	26.8	30.8	35.0	39.5	44.3	47.6
		HPZ	22.0	23.9	28.1	32.5	37.4	42.5	48.0	53.8	57.8

LPZ – Low Pressure Zone 2 for Hip Roofs. HPZ – High Pressure Zone 3 for Hip Roofs.

Wind speeds are  $V_{ult}$ . Refer to the tile manufacturer for additional information.

See Figures 1.0 & 2.0 on page 22 for additional details on roof zone designations.

**TABLE 2 HD**  
**Hip Roof – ASCE 7-22**  
**Exposure D – Tile Factor = 1.407 ft<sup>3</sup>**

Roof Slopes	Mean Roof Heights (ft)	Roof Zones	115	120	130	140	150	160	170	180	190
			Ma (ft-lbf)	Ma (ft-lbf)	Ma (ft-lbf)	Ma (ft-lbf)	Ma (ft-lbf)	Ma (ft-lbf)	Ma (ft-lbf)	Ma (ft-lbf)	Ma (ft-lbf)
Less than 4.5:12	0-15	LPZ	20.0	21.8	25.6	29.7	34.1	38.8	43.7	49.0	54.0
		HPZ	21.2	23.1	27.1	31.4	36.1	41.0	46.3	51.9	57.9
	20	LPZ	21.0	22.9	26.8	31.1	35.7	40.6	45.9	51.4	57.3
		HPZ	22.2	24.2	28.4	32.9	37.8	43.0	48.6	54.5	60.7
	30	LPZ	22.5	24.5	28.8	33.4	38.4	43.6	49.3	55.2	61.5
		HPZ	23.9	26.0	30.5	35.4	40.6	46.2	52.2	58.5	65.2
	40	LPZ	23.7	25.8	30.3	35.1	40.3	45.9	51.8	58.1	64.7
		HPZ	25.1	27.3	32.1	37.2	42.7	48.6	54.9	61.5	68.5
	50	LPZ	24.7	26.9	31.5	36.6	42.0	47.8	53.9	60.5	67.4
		HPZ	26.1	28.5	33.4	38.7	44.5	50.6	57.1	64.0	71.3
	60	LPZ	25.5	27.7	32.5	37.7	43.3	49.3	55.6	62.4	69.5
		HPZ	27.0	29.4	34.5	40.0	45.9	52.2	58.9	66.0	73.6
4.5:12 to less than 6:12	0-15	LPZ	17.7	19.2	22.6	26.2	30.1	34.2	38.6	43.3	48.2
		HPZ	17.7	19.2	22.6	26.2	30.1	34.2	38.6	43.3	48.2
	20	LPZ	18.5	20.2	23.7	27.4	31.5	35.9	40.5	45.4	50.6
		HPZ	18.5	20.2	23.7	27.4	31.5	35.9	40.5	45.4	50.6
	30	LPZ	19.9	21.7	25.4	29.5	33.8	38.5	43.5	48.7	54.3
		HPZ	19.9	21.7	25.4	29.5	33.8	38.5	43.5	48.7	54.3
	40	LPZ	20.9	22.8	26.7	31.0	35.6	40.5	45.7	51.3	57.1
		HPZ	20.9	22.8	26.7	31.0	35.6	40.5	45.7	51.3	57.1
	50	LPZ	21.8	23.7	27.8	32.3	37.1	42.2	47.6	53.4	59.5
		HPZ	21.8	23.7	27.8	32.3	37.1	42.2	47.6	53.4	59.5
	60	LPZ	22.5	24.5	28.7	33.3	38.2	43.5	49.1	55.0	61.3
		HPZ	22.5	24.5	28.7	33.3	38.2	43.5	49.1	55.0	61.3
6:12 to 12:12	0-15	LPZ	16.5	18.0	21.1	24.4	28.0	31.9	36.0	40.4	45.0
		HPZ	20.0	21.8	25.6	29.7	34.1	38.8	43.7	49.0	54.6
	20	LPZ	17.3	18.8	22.1	25.6	29.4	33.5	37.8	42.4	47.2
		HPZ	21.0	22.9	26.8	31.1	35.7	40.6	45.9	51.4	57.3
	30	LPZ	18.6	20.2	23.7	27.5	31.6	35.9	40.6	45.5	50.7
		HPZ	22.5	24.5	28.8	33.4	38.4	43.6	49.3	55.2	61.5
	40	LPZ	19.5	21.3	25.0	28.9	33.2	37.8	42.7	47.8	53.3
		HPZ	23.7	25.8	30.3	35.1	40.3	45.9	51.8	58.1	64.7
	50	LPZ	20.3	22.1	26.0	30.1	34.6	39.3	44.4	49.4	54.5
		HPZ	24.7	26.9	31.5	36.6	42.0	47.8	53.9	59.9	65.9
	60	LPZ	21.0	22.8	26.8	31.1	35.7	40.6	45.8	50.8	55.8
		HPZ	25.5	27.7	32.5	37.7	43.3	49.3	55.6	61.6	67.6

LPZ – Low Pressure Zone 2 for Hip Roofs. HPZ – High Pressure Zone 3 for Hip Roofs.

Wind speeds are  $V_{ult}$ . Refer to the tile manufacturer for additional information.

See Figures 1.0 & 2.0 on page 22 for additional details on roof zone designations.

**TABLE 2 GB**  
**Gable Roof – ASCE 7-22**  
**Exposure B – Tile Factor = 1.407 ft<sup>3</sup>**

Roof Slopes	Mean Roof Heights (ft)	Roof Zones	115	120	130	140	150	160	170	180	190
			Ma (ft-lbf)	Ma (ft-lbf)	Ma (ft-lbf)	Ma (ft-lbf)	Ma (ft-lbf)	Ma (ft-lbf)	Ma (ft-lbf)	Ma (ft-lbf)	Ma (ft-lbf)
Less than 4.5:12	0-15	LPZ	14.8	16.1	18.9	21.9	25.2	28.7	32.4	36.3	40.4
		HPZ	18.4	20.0	23.5	27.3	31.3	35.6	40.2	45.1	50.2
	20	LPZ	14.8	16.1	18.9	21.9	25.2	28.7	32.4	36.3	40.4
		HPZ	18.4	20.0	23.5	27.3	31.3	35.6	40.2	45.1	50.2
	30	LPZ	14.8	16.1	18.9	21.9	25.2	28.7	32.4	36.3	40.4
		HPZ	18.4	20.0	23.5	27.3	31.3	35.6	40.2	45.1	50.2
	40	LPZ	15.7	17.0	20.0	23.2	26.6	30.3	34.2	38.3	42.7
		HPZ	19.5	21.2	24.9	28.8	33.1	37.7	42.5	47.7	53.1
	50	LPZ	16.7	18.2	21.4	24.8	28.4	32.3	36.5	40.9	45.6
		HPZ	20.8	22.6	26.5	30.8	35.3	40.2	45.4	50.9	56.7
	60	LPZ	17.6	19.1	22.4	26.0	29.9	34.0	38.4	43.0	47.9
		HPZ	21.8	23.8	27.9	32.3	37.1	42.2	47.7	53.5	59.6
4.5:12 to less than 6:12	0-15	LPZ	17.0	18.5	21.7	25.2	28.9	32.9	37.2	41.7	46.4
		HPZ	19.4	21.2	24.8	28.8	33.1	37.6	42.5	47.6	53.1
	20	LPZ	17.0	18.5	21.7	25.2	28.9	32.9	37.2	41.7	46.4
		HPZ	19.4	21.2	24.8	28.8	33.1	37.6	42.5	47.6	53.1
	30	LPZ	17.0	18.5	21.7	25.2	28.9	32.9	37.2	41.7	46.4
		HPZ	19.4	21.2	24.8	28.8	33.1	37.6	42.5	47.6	53.1
	40	LPZ	18.0	19.6	23.0	26.7	30.6	34.9	39.4	44.1	49.2
		HPZ	20.6	22.4	26.3	30.5	35.0	39.8	45.0	50.4	56.2
	50	LPZ	18.8	20.5	24.0	27.9	32.0	36.4	41.1	46.1	51.3
		HPZ	21.5	23.4	27.7	31.9	36.6	41.6	47.0	52.7	58.7
	60	LPZ	19.6	21.3	25.1	29.1	33.4	38.0	42.8	48.0	53.5
		HPZ	22.4	24.4	28.6	33.2	38.1	43.4	49.0	54.9	61.2
6:12 to 12:12	0-15	LPZ	12.0	13.1	15.3	17.8	20.4	23.2	26.2	29.4	32.8
		HPZ	14.0	15.2	17.9	20.8	23.8	27.1	30.6	34.3	38.2
	20	LPZ	12.0	13.1	15.3	17.8	20.4	23.2	26.2	29.4	32.8
		HPZ	14.0	15.2	17.9	20.8	23.8	27.1	30.6	34.3	38.2
	30	LPZ	12.0	13.1	15.3	17.8	20.4	23.2	26.2	29.4	32.8
		HPZ	14.0	15.2	17.9	20.8	23.8	27.1	30.6	34.3	38.2
	40	LPZ	12.7	13.8	16.2	18.8	21.6	24.6	27.7	31.1	34.6
		HPZ	14.8	16.1	18.9	21.9	25.2	28.7	32.4	36.3	40.4
	50	LPZ	13.5	14.8	17.3	20.1	23.0	26.2	29.6	33.2	37.0
		HPZ	15.8	17.2	20.2	23.4	26.9	30.6	34.5	38.7	43.1
	60	LPZ	14.2	15.5	18.2	21.1	24.2	27.6	31.1	34.9	38.9
		HPZ	16.6	18.1	21.2	24.6	28.3	32.1	36.3	40.7	45.3

a = 10% of least horizontal dimension or 0.4h, whichever is smaller, but not less than either 4% of least horizontal dimension or 3 ft (0.9 m)

LPZ = Low Pressure Zone = 2 for Gable Roofs; HPZ = High Pressure Zone = 3 for Gable Roofs

Refer to tile manufacturers for additional information on tile installation requirements

**TABLE 2 GC**  
**Gable Roof – ASCE 7-22**  
**Exposure C – Tile Factor = 1.407 ft<sup>3</sup>**

Roof Slopes	Mean Roof Heights (ft)	Roof Zones	115	120	130	140	150	160	170	180	190
			Ma (ft-lbf)	Ma (ft-lbf)	Ma (ft-lbf)	Ma (ft-lbf)	Ma (ft-lbf)	Ma (ft-lbf)	Ma (ft-lbf)	Ma (ft-lbf)	Ma (ft-lbf)
Less than 4.5:12	0-15	LPZ	18.0	19.6	23.0	26.6	30.6	34.8	39.3	44.0	49.1
		HPZ	22.4	24.3	28.6	33.1	38.0	43.3	48.8	54.8	61.0
	20	LPZ	19.0	20.7	24.3	28.2	32.4	36.8	41.6	46.6	52.0
		HPZ	23.7	25.8	30.2	35.1	40.3	45.8	51.7	58.0	64.6
	30	LPZ	20.7	22.6	26.5	30.7	35.3	40.1	45.3	50.8	56.6
		HPZ	25.8	28.1	32.9	38.2	43.8	49.9	56.3	63.1	70.3
	40	LPZ	22.0	24.0	28.1	32.6	37.4	42.6	48.1	53.9	60.0
		HPZ	27.3	29.8	34.9	40.5	46.5	52.9	59.8	67.0	74.7
	50	LPZ	23.1	25.1	29.5	34.2	39.2	44.6	50.4	56.5	62.9
		HPZ	28.7	31.2	36.6	42.5	48.8	55.5	62.6	70.2	78.2
	60	LPZ	23.9	26.0	30.5	35.4	40.7	46.3	52.2	58.6	65.2
		HPZ	29.7	32.4	38.0	44.0	50.6	57.5	64.9	72.8	81.1
4.5:12 to less than 6:12	0-15	LPZ	17.0	18.5	21.7	25.2	28.9	32.9	37.2	41.7	46.4
		HPZ	19.4	21.2	24.8	28.8	33.1	37.6	42.5	47.6	53.1
	20	LPZ	18.0	19.6	23.0	26.7	30.6	34.9	39.4	44.1	49.2
		HPZ	20.6	22.4	26.3	30.5	35.0	39.8	45.0	50.4	56.2
	30	LPZ	19.6	21.3	25.1	29.1	33.4	38.0	42.8	48.0	53.5
		HPZ	22.4	24.4	28.6	33.2	38.1	43.4	49.0	54.9	61.2
	40	LPZ	20.8	22.7	26.6	30.8	35.4	40.3	45.5	51.0	56.8
		HPZ	23.8	25.9	30.4	35.2	40.5	46.0	52.0	58.3	64.9
	50	LPZ	21.8	23.7	27.9	32.3	37.1	42.2	47.7	53.4	59.5
		HPZ	24.9	27.1	31.9	36.9	42.4	48.2	54.5	61.1	68.0
	60	LPZ	22.6	24.6	28.9	33.5	38.5	43.8	49.4	55.4	61.7
		HPZ	25.8	28.1	33.0	38.3	44.0	50.0	56.5	63.3	70.5
6:12 to 12:12	0-15	LPZ	14.6	15.9	18.6	21.6	24.8	28.2	31.9	35.7	39.8
		HPZ	17.0	18.5	21.7	25.2	28.9	32.9	37.2	41.7	46.4
	20	LPZ	15.4	16.8	19.7	22.9	26.3	29.9	33.7	37.8	42.1
		HPZ	18.0	19.6	23.0	26.7	30.6	34.9	39.4	44.1	49.2
	30	LPZ	16.8	18.3	21.5	24.9	28.6	32.5	36.7	41.2	45.9
		HPZ	19.6	21.3	25.1	29.1	33.4	38.0	42.8	48.0	53.5
	40	LPZ	17.8	19.4	22.8	26.4	30.3	34.5	39.0	43.7	48.7
		HPZ	20.8	22.7	26.6	30.8	35.4	40.3	45.5	51.0	56.8
	50	LPZ	18.7	20.4	23.9	27.7	31.8	36.2	40.8	45.8	51.0
		HPZ	21.8	23.7	27.9	32.3	37.1	42.2	47.7	53.4	59.5
	60	LPZ	19.4	21.1	24.8	28.7	33.0	37.5	42.3	47.5	52.9
		HPZ	22.6	24.6	28.9	33.5	38.5	43.8	49.4	55.4	61.7

a = 10% of least horizontal dimension or 0.4h, whichever is smaller, but not less than either 4% of least horizontal dimension or 3 ft (0.9 m)

LPZ = Low Pressure Zone = 2 for Gable Roofs; HPZ = High Pressure Zone = 3 for Gable Roofs

Refer to tile manufacturers for additional information on tile installation requirements

**TABLE 2 GD**  
**Gable Roof – ASCE 7-22**  
**Exposure D – Tile Factor = 1.407 ft<sup>3</sup>**

Roof Slopes	Mean Roof Heights (ft)	Roof Zones	115	120	130	140	150	160	170	180	190
			Ma (ft-lbf)	Ma (ft-lbf)	Ma (ft-lbf)	Ma (ft-lbf)	Ma (ft-lbf)	Ma (ft-lbf)	Ma (ft-lbf)	Ma (ft-lbf)	Ma (ft-lbf)
Less than 4.5:12	0-15	LPZ	21.8	23.7	27.8	32.3	37.1	42.2	47.6	53.4	59.5
		HPZ	27.1	29.5	34.6	40.1	46.1	52.4	59.2	66.4	73.9
	20	LPZ	22.8	24.9	29.2	33.9	38.9	44.2	49.9	56.0	62.4
		HPZ	28.4	30.9	36.3	42.1	48.3	55.0	62.1	69.6	77.5
	30	LPZ	24.5	26.7	31.4	36.4	41.7	47.5	53.6	60.1	67.0
		HPZ	30.5	33.2	39.0	45.2	51.9	59.0	66.7	74.7	83.3
	40	LPZ	25.8	28.1	33.0	38.2	43.9	50.0	56.4	63.2	70.4
		HPZ	32.1	34.9	41.0	47.5	54.6	62.1	70.1	78.6	87.6
	50	LPZ	26.9	29.2	34.3	39.8	45.7	52.0	58.7	65.8	73.3
		HPZ	33.4	36.4	42.7	49.5	56.8	64.6	73.0	81.8	91.2
	60	LPZ	27.7	30.2	35.4	41.1	47.1	53.6	60.5	67.9	75.6
		HPZ	34.4	37.5	44.0	51.1	58.6	66.7	75.3	84.4	94.0
4.5:12 to less than 6:12	0-15	LPZ	20.6	22.4	26.3	30.5	35.1	39.9	45.0	50.5	56.3
		HPZ	23.6	25.6	30.1	34.9	40.1	45.6	51.5	57.7	64.3
	20	LPZ	21.6	23.5	27.6	32.0	36.8	41.8	47.2	52.9	59.0
		HPZ	24.7	26.9	31.6	36.6	42.0	47.8	54.0	60.5	67.4
	30	LPZ	23.2	25.3	29.7	34.4	39.5	44.9	50.7	56.9	63.4
		HPZ	26.5	28.9	33.9	39.3	45.1	51.3	58.0	65.0	72.4
	40	LPZ	24.4	26.6	31.2	36.2	41.5	47.3	53.3	59.8	66.6
		HPZ	27.9	30.4	35.6	41.3	47.5	54.0	61.0	68.3	76.1
	50	LPZ	25.4	27.7	32.5	37.7	43.2	49.2	55.5	62.3	69.4
		HPZ	29.0	31.6	37.1	43.0	49.4	56.2	63.5	71.1	79.3
	60	LPZ	26.2	28.5	33.5	38.8	44.6	50.7	57.3	64.2	71.5
		HPZ	30.0	32.6	38.3	44.4	51.0	58.0	65.5	73.4	81.8
6:12 to 12:12	0-15	LPZ	17.7	19.2	22.6	26.2	30.1	34.2	38.6	43.3	48.2
		HPZ	20.6	22.4	26.3	30.5	35.1	39.9	45.0	50.5	56.3
	20	LPZ	18.5	20.2	23.7	27.4	31.5	35.9	40.5	45.4	50.6
		HPZ	21.6	23.5	27.6	32.0	36.8	41.8	47.2	52.9	59.0
	30	LPZ	19.9	21.7	25.4	29.5	33.8	38.5	43.5	48.7	54.3
		HPZ	23.2	25.3	29.7	34.4	39.5	44.9	50.7	56.9	63.4
	40	LPZ	20.9	22.8	26.7	31.0	35.6	40.5	45.7	51.3	57.1
		HPZ	24.4	26.6	31.2	36.2	41.5	47.3	53.3	59.8	66.6
	50	LPZ	21.8	23.7	27.8	32.3	37.1	42.2	47.6	53.4	59.5
		HPZ	25.4	27.7	32.5	37.7	43.2	49.2	55.5	62.3	69.4
	60	LPZ	22.5	24.5	28.7	33.3	38.2	43.5	49.1	55.0	61.3
		HPZ	26.2	28.5	33.5	38.8	44.6	50.7	57.3	64.2	71.5

a = 10% of least horizontal dimension or 0.4h, whichever is smaller, but not less than either 4% of least horizontal dimension or 3 ft (0.9 m)

LPZ = Low Pressure Zone = 2 for Gable Roofs; HPZ = High Pressure Zone = 3 for Gable Roofs

Refer to tile manufacturers for additional information on tile installation requirements



**TABLE 3**  
**Mechanical Fastening for Concrete and Clay Tiles**  
**Mechanical Fastening Resistance Values on Plywood (ft-lbf)**

Deck Thickness	Method	Fastener Type	Attachment Description	Low	Medium	High
15/32"	Direct Deck	Nail	1 SS, 1 C	25.2	25.2	35.5
			2 SS, 1 C	38.1	38.1	44.3
			2 RS	39.1	36.1	28.6
	Batten	Screw	1 #8 Screw	39.1	33.2	28.7
			2 #8 Screws	50.2	55.5	51.3
			1 SS, 1 C	27.5	27.5	29.4
Batten	Nail	2 SS, 1 C	37.6	37.6	47.2	
		2 RS	24.6	36.4	26.8	
		1 #8 Screw	25.6	30.1	25.5	
19/32"	Direct Deck	Nail	2 #8 Screws	36.1	41.9	37.1
			2 RS	46.4	45.5	41.2

SS = Smooth Shank Nail C = Clip RS = Ring Shank  
 (See page 5 for descriptions and requirements of specific fasteners).

For mean roof heights (MRH) above 60 ft, engineering calculations must be submitted for permitting.

For attachment systems not listed in the table for 19/32" sheathing, use the allowable aerodynamic uplift resistance from the table for 15/32" sheathing.

The allowable aerodynamic uplift moments include a generic restoring gravity moment of 6.5 ft-lbf for a direct deck and a restoring gravity moment of 5.5 ft-lbs for a batten installation.

The fastener hole nearest the overlock shall be used when a single nail or screw is required. The fastener hole nearest the underlock and the fastener hole nearest the overlock shall be used when two nails or screws are used.

Fasteners shall be located a minimum of 1.5" from the head of the tile.

**Note:** Foam applied systems require FBC Product Approval. Refer to the roof tile foam adhesive manufacturer for Product Approval and installation instructions.

ASCE 7-22 WIND MAP

Ultimate Design Wind Speeds,  $V_{ULT}$ , For Risk Category II Buildings and Other Structures

APPENDIX A

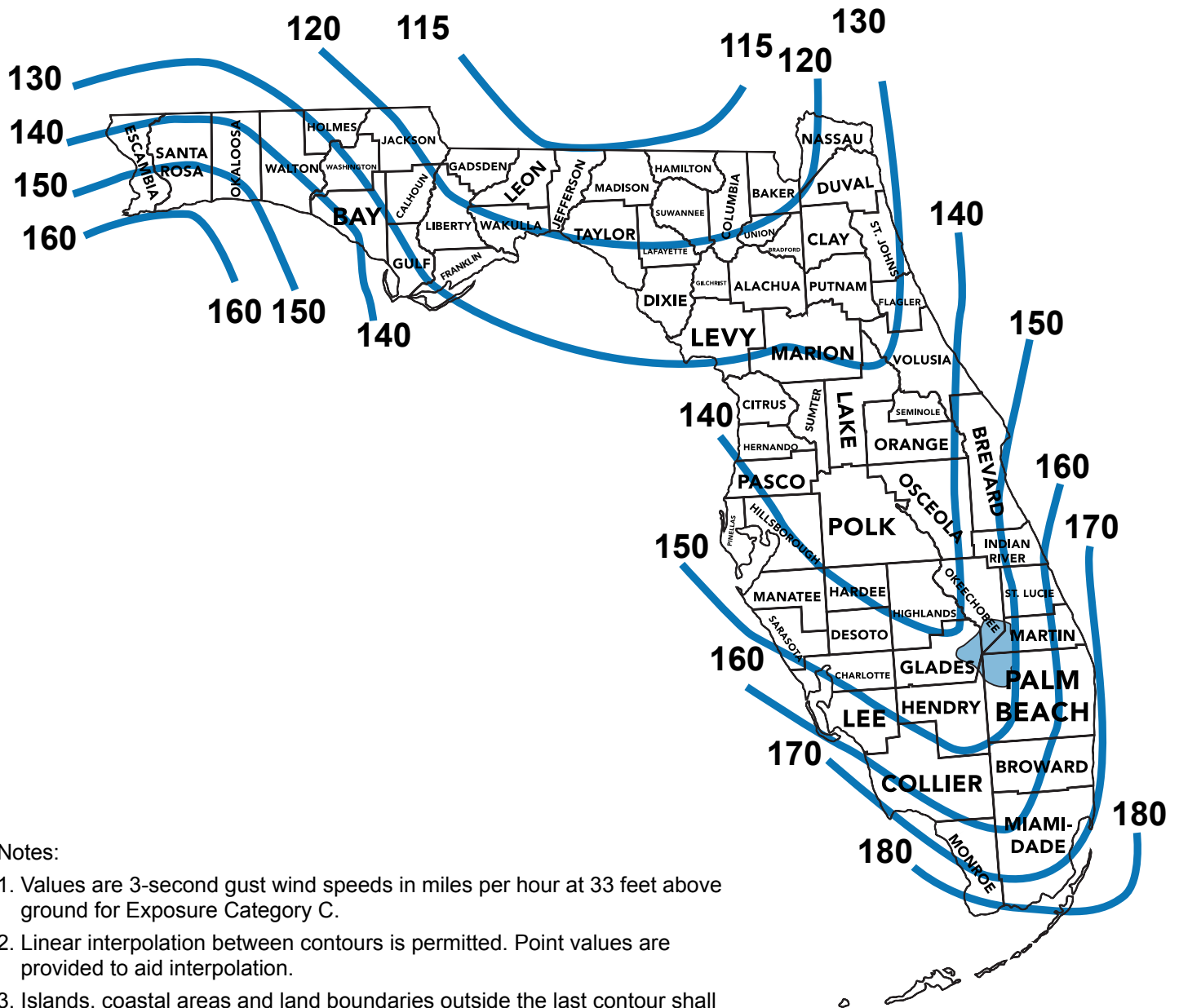

Notes:

1. Values are 3-second gust wind speeds in miles per hour at 33 feet above ground for Exposure Category C.
2. Linear interpolation between contours is permitted. Point values are provided to aid interpolation.
3. Islands, coastal areas and land boundaries outside the last contour shall use the last wind speed contour.
4. Location-specific basic wind speeds shall be permitted to be determined using the ASCE Wind Design Geodatabase.
5. Wind speeds for Hawaii, US Virgin Islands and Puerto Rico shall be determined from the ASCE Wind Design Geodatabase.
6. Mountainous terrain, gorges, ocean promontories and special wind regions shall be examined for unusual wind conditions. Site-specific values for selected special wind regions shall be permitted to be determined using the ASCE Wind Design Geodatabase.
7. Wind speeds correspond to approximately a 15% probability of exceedance in 50 years. Annual Exceedance Probability = 0.00143, MRI = 700 years.
8. The ASCE Wind Design Geodatabase can be accessed at the ASCE 7 Hazard Tool (<https://asce7hazardtool.online>) or approved equivalent.

**UNDERLAYMENT APPLICATION - TWO-PLY**

HOT MOP, COLD APPLIED

**FHW-01**

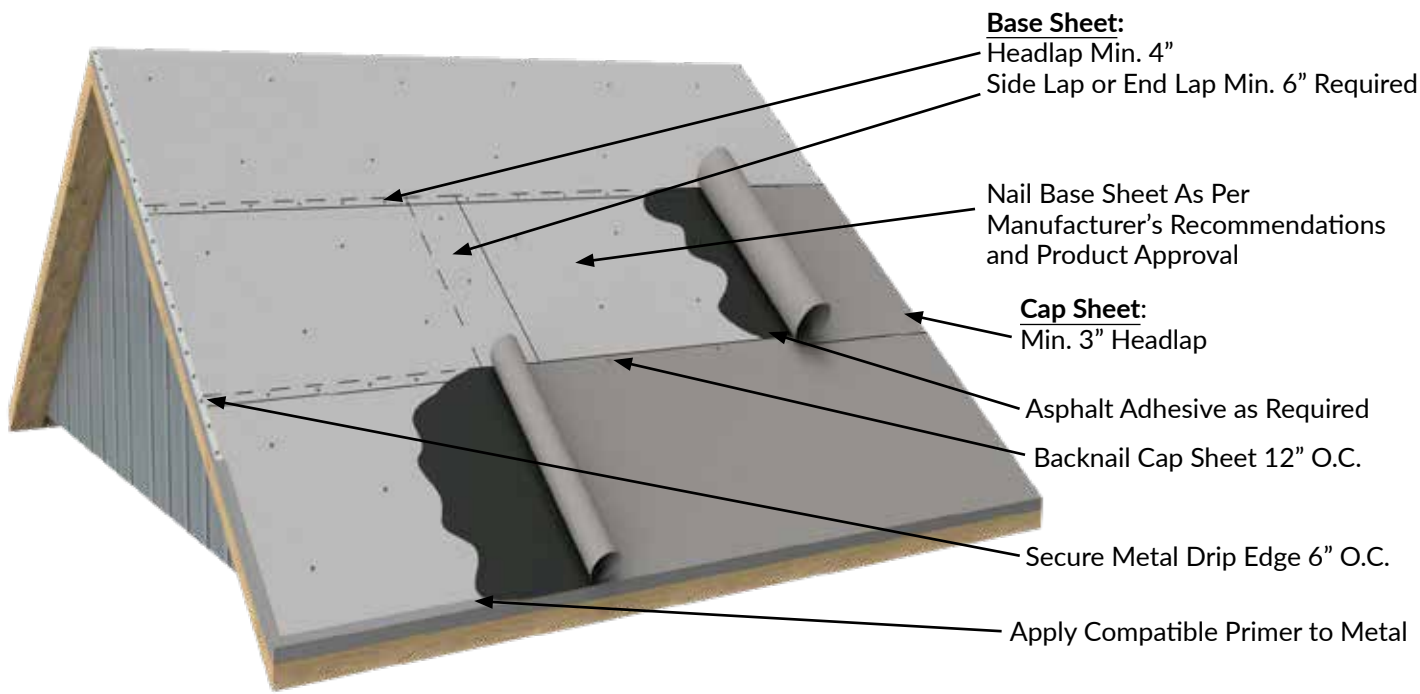

**UNDERLAYMENT APPLICATION - TWO-PLY**

SELF-ADHERED

**FHW-02**

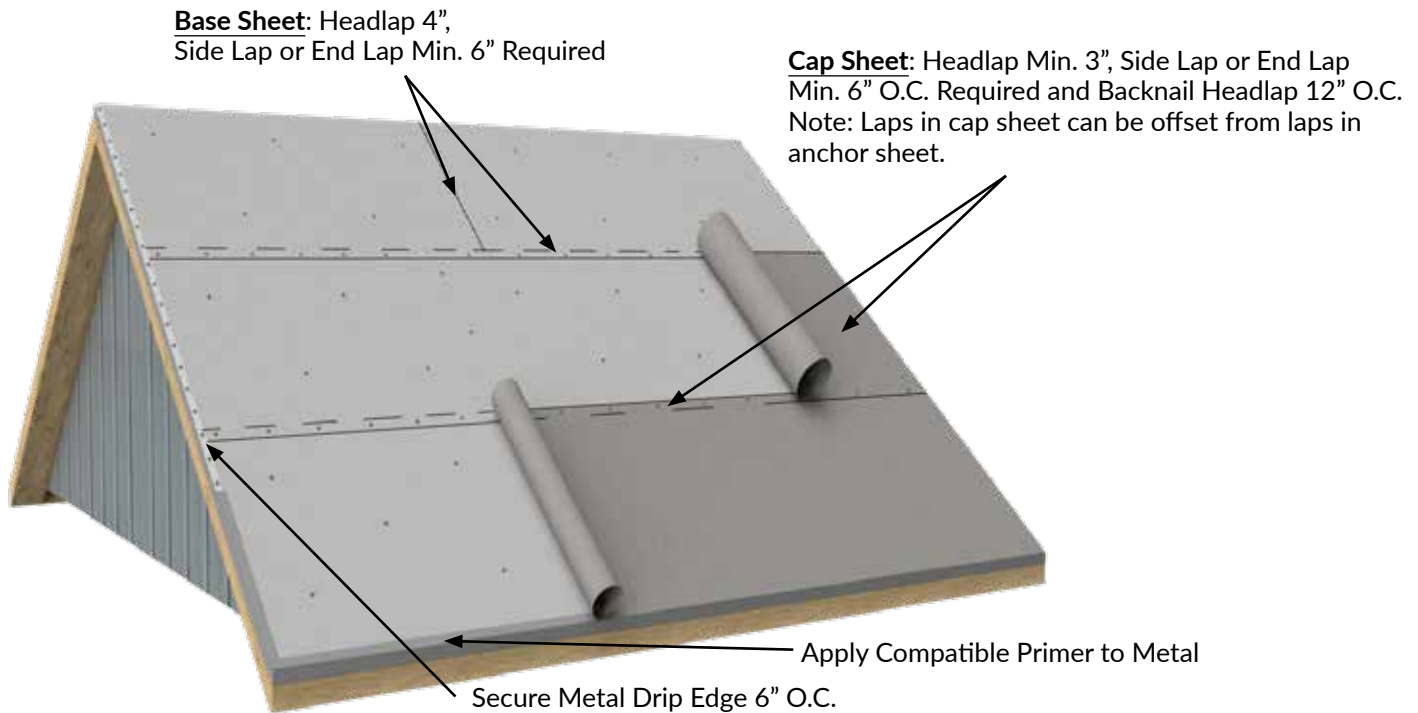

**NOTE** – Drawings are for illustrative purposes and do not reflect all methods of installation. Please refer to written text.

SELF ADHERED - SINGLE-PLY

FHW-03

Secure Metal Drip Edge 6" O.C.

Separator Sheet or Prime Deck

Apply Compatible Primer

Backnail Cap Sheet 12" O.C.

Plywood

Min. 6" Sealed Side Lap/End Lap

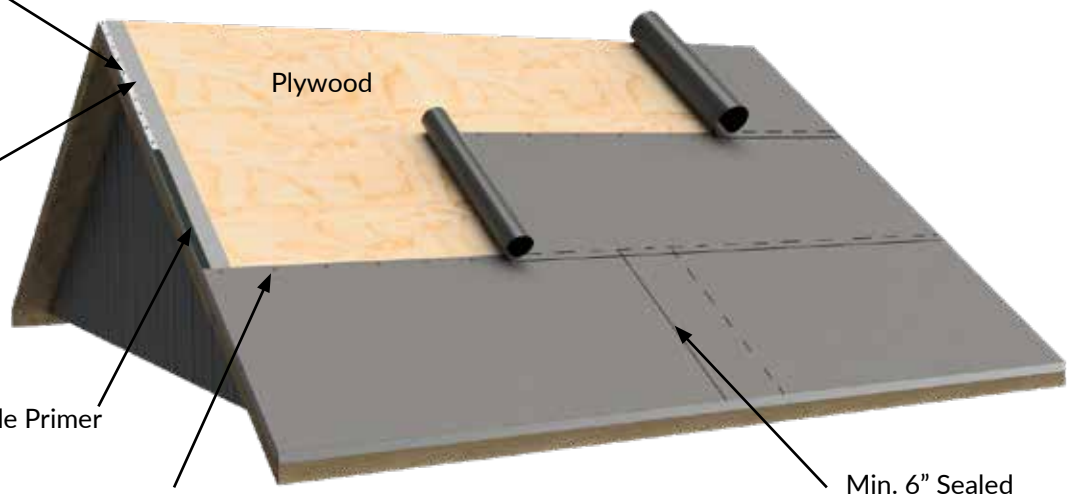

UNDERLAYMENT AT VALLEY

OPTIONS: WOVEN, UNDERCUT

FHW-04

Optional 36" Sweat Sheet

Roof Deck

Optional 36" Sweat Sheet

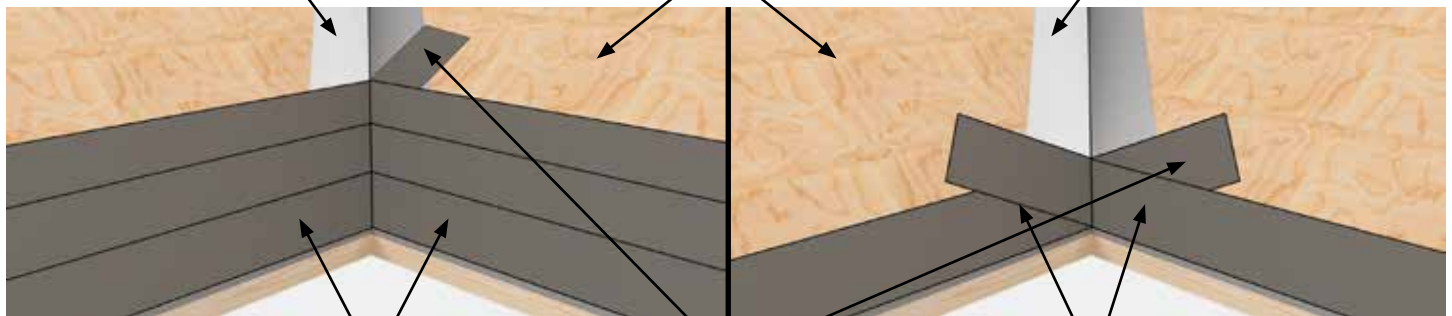

Center (Closed) Cut Valley

Underlayment Woven or Extended Through Valley Line a Min. 12"

Woven Valley

NOTE – Drawings are for illustrative purposes and do not reflect all methods of installation. Please refer to written text.

REQUIRED VALLEY METAL OPTIONS

FHW-05

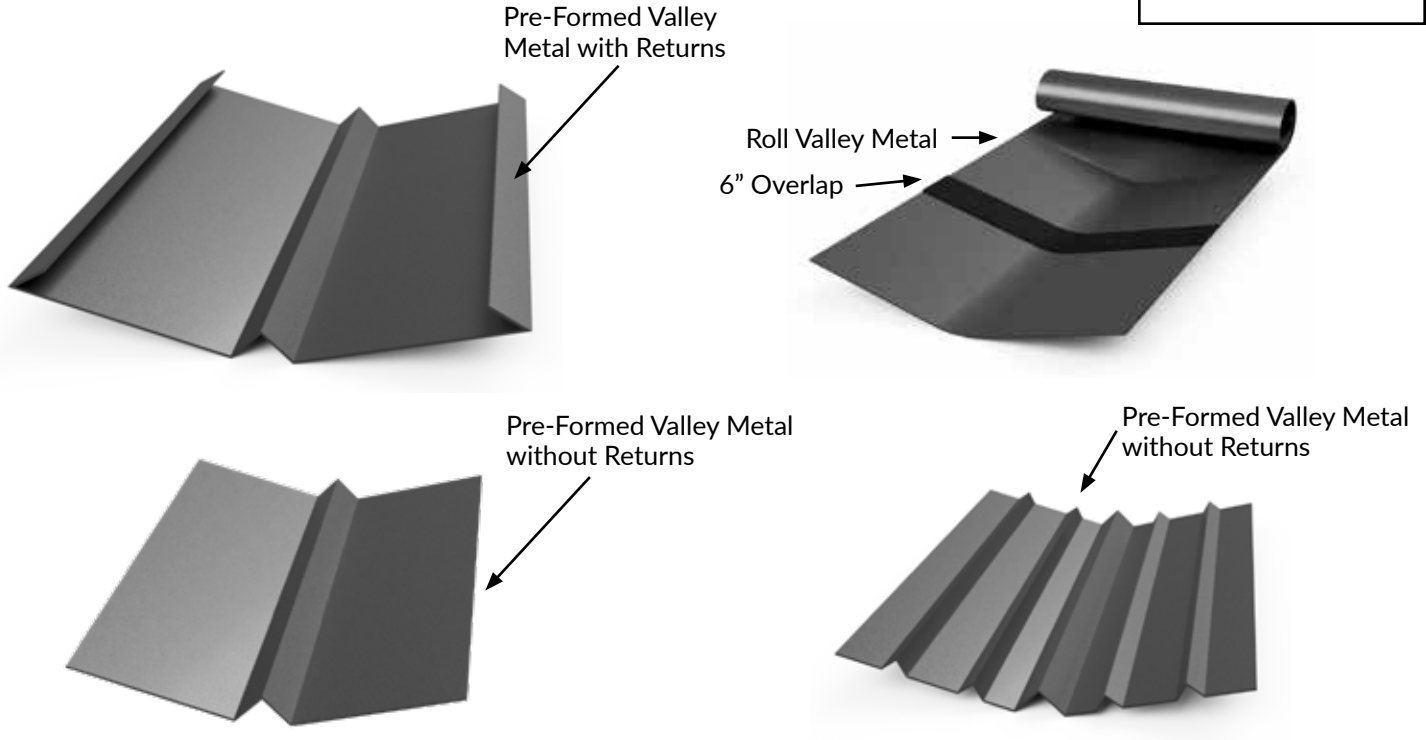

Bead of Sealant or Separator Sheet Required at the 6" Overlap

VALLEYS

OPEN OR CLOSED

FHW-06

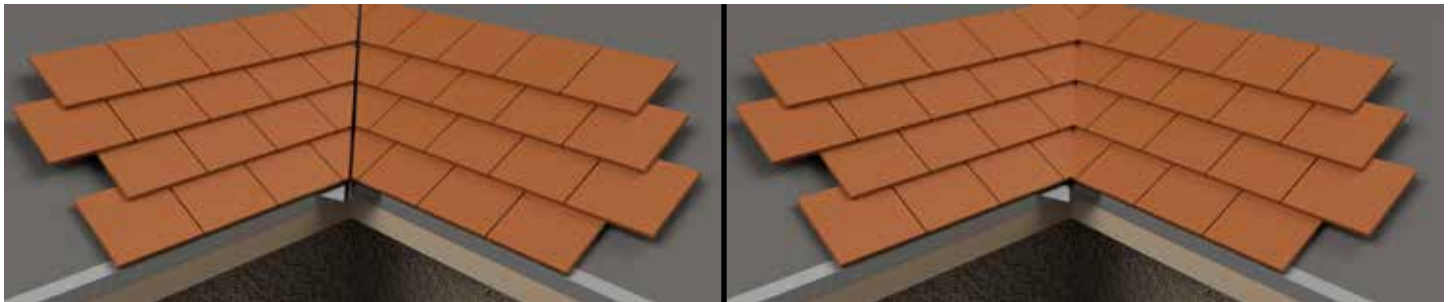

Open Mitered Pre-Formed Metal

Closed Mitered Rolled Metal

NOTE – Drawings are for illustrative purposes and do not reflect all methods of installation. Please refer to written text.

TRANSITIONAL FLASHING

FHW-07

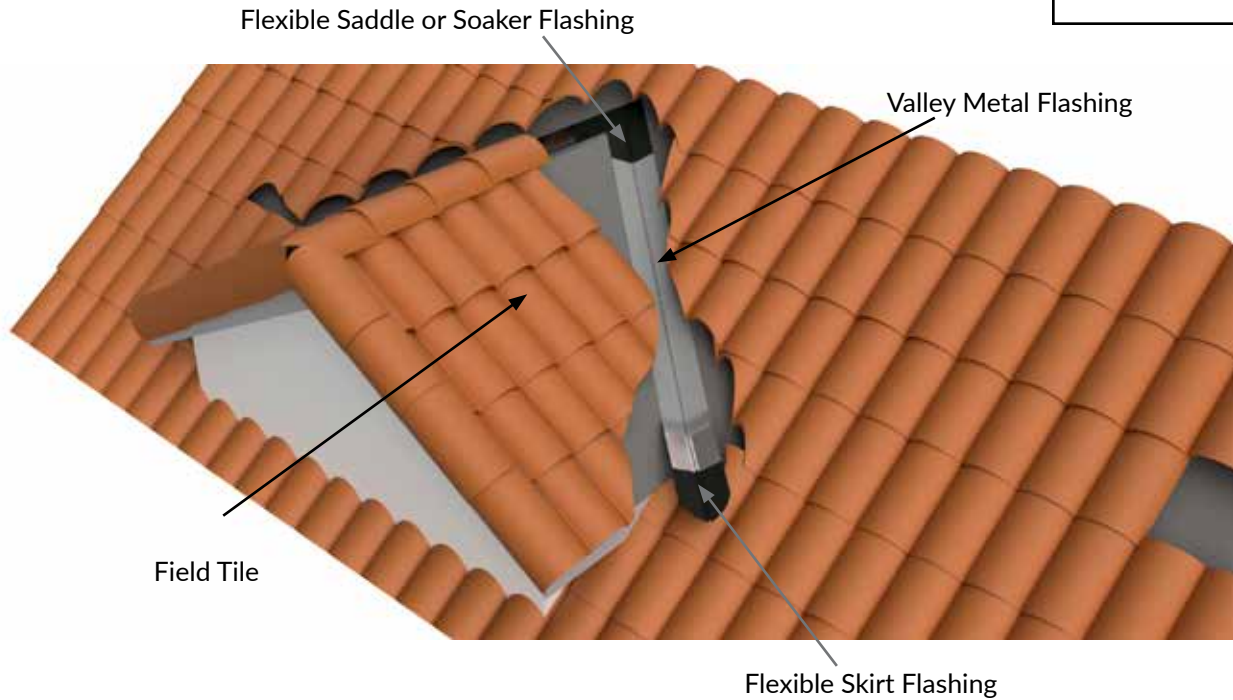

Note: Flashing that terminate in the field of the roof require transitional flashing.

VALLEY METAL - TWO-PLY SYSTEM

FHW-08

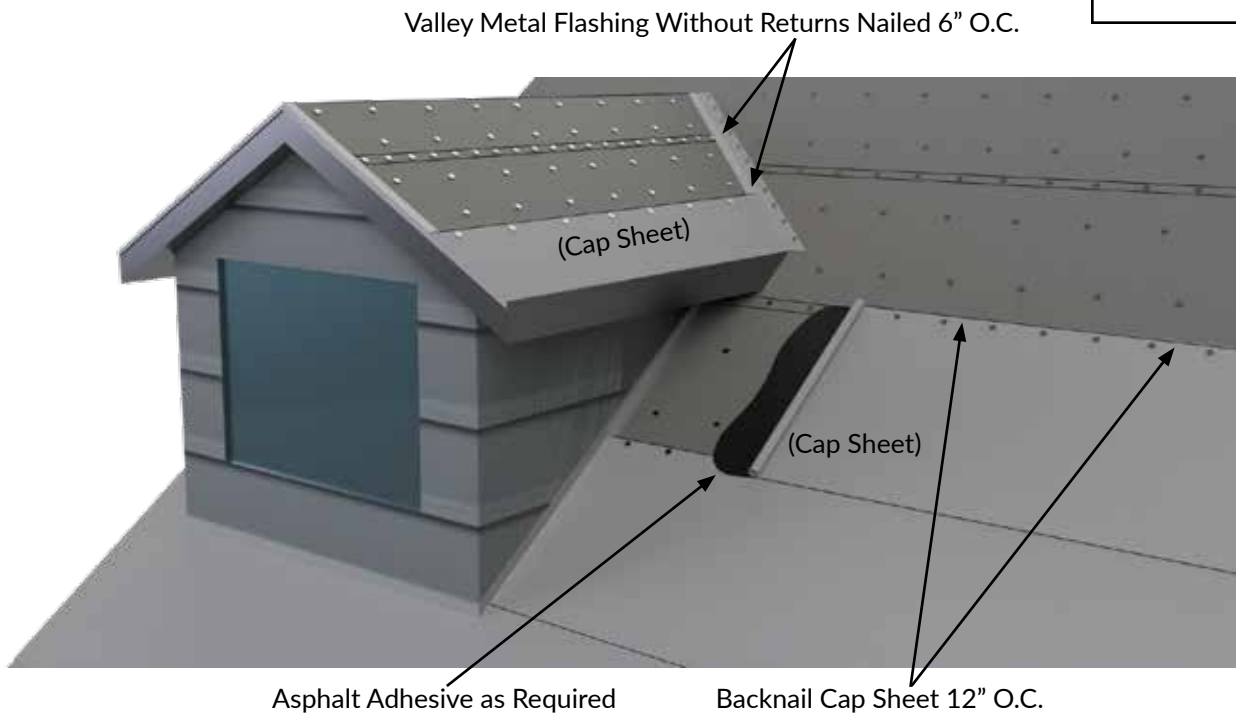

NOTE – Drawings are for illustrative purposes and do not reflect all methods of installation. Please refer to written text.

SIDE WALL FLASHING WITH KICKER DETAIL

FHW-09

APPENDIX B

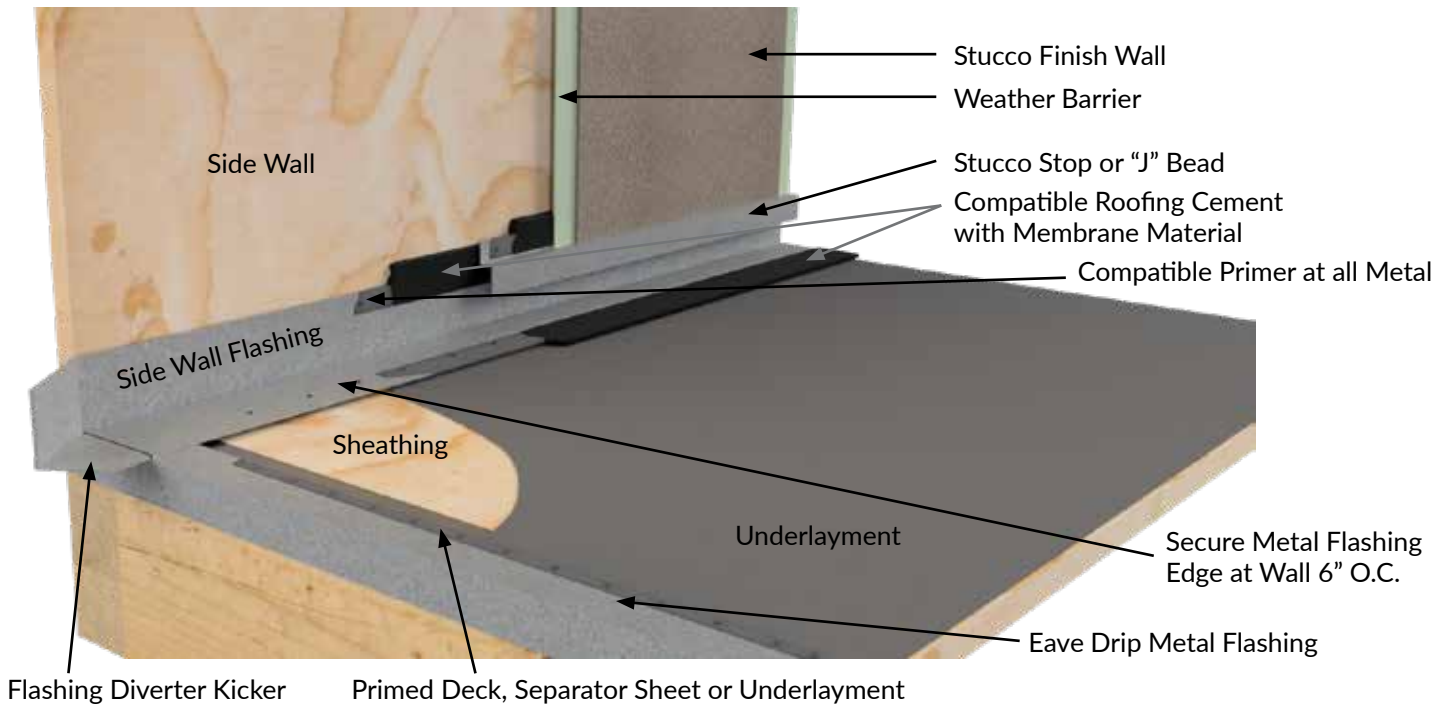

FLASHING AND COUNTER FLASHING

AT WALL ABUTMENTS

FHW-10

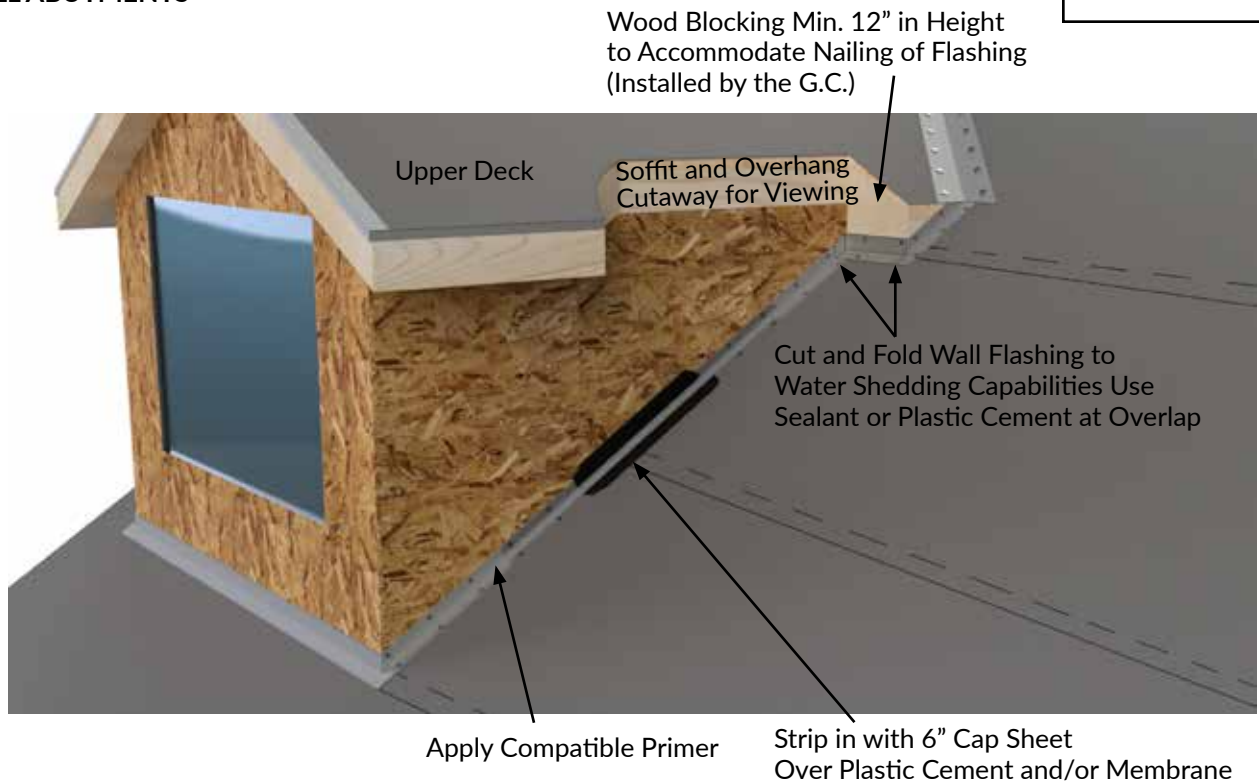

**NOTE** – Drawings are for illustrative purposes and do not reflect all methods of installation. Please refer to written text.

### WALL FLASHING EXAMPLES

PRE-FORMED METALS

FHW-11

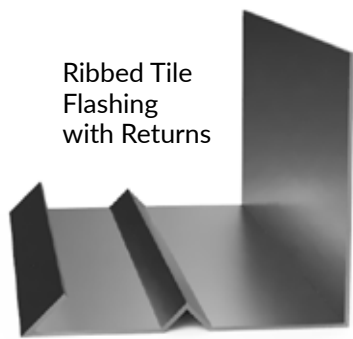
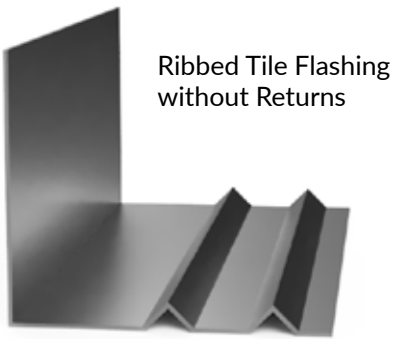
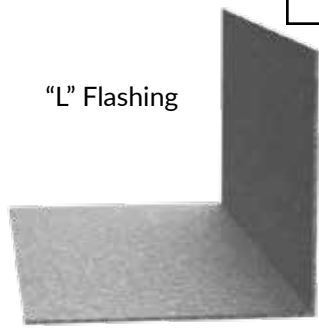
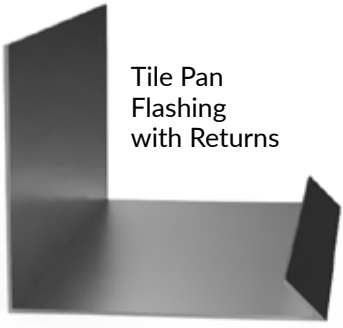

Bead of Sealant or Separator Sheet Required at the 6" Overlap

### WALL FLASHING

PRE-FORMED METAL WITH RETURNS

FHW-12

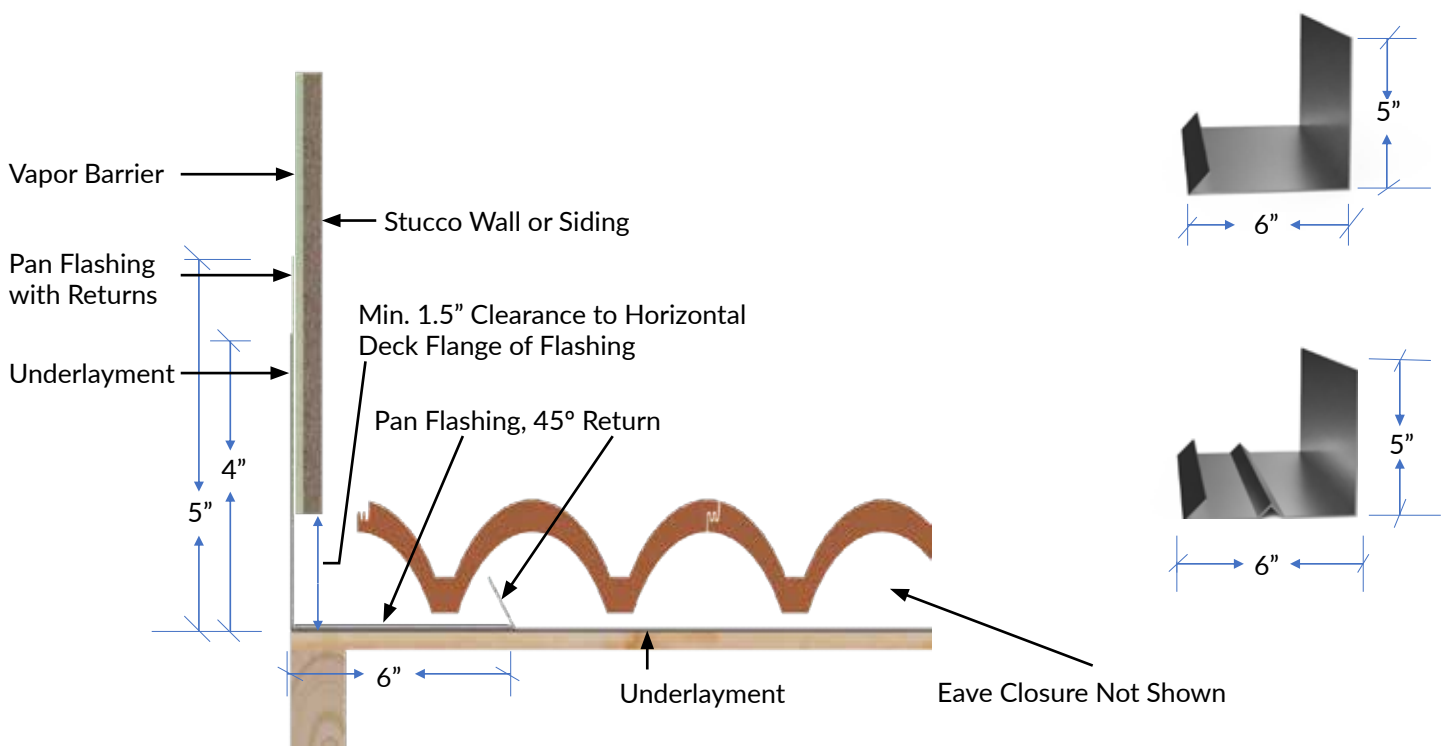

NOTE – Drawings are for illustrative purposes and do not reflect all methods of installation. Please refer to written text.



SLOPE CHANGE APPLICATIONS

FHW-13

APPENDIX B

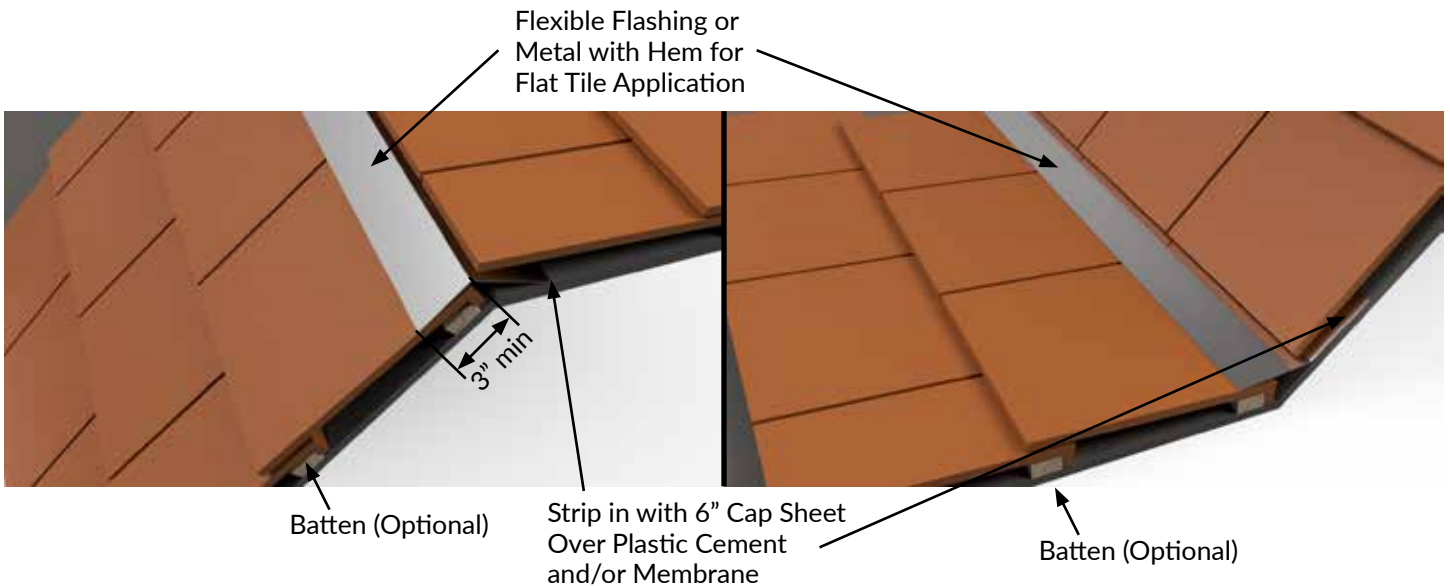

EAVE TREATMENT

EAVE CLOSURE AND ANTI-PONDING

FHW-14

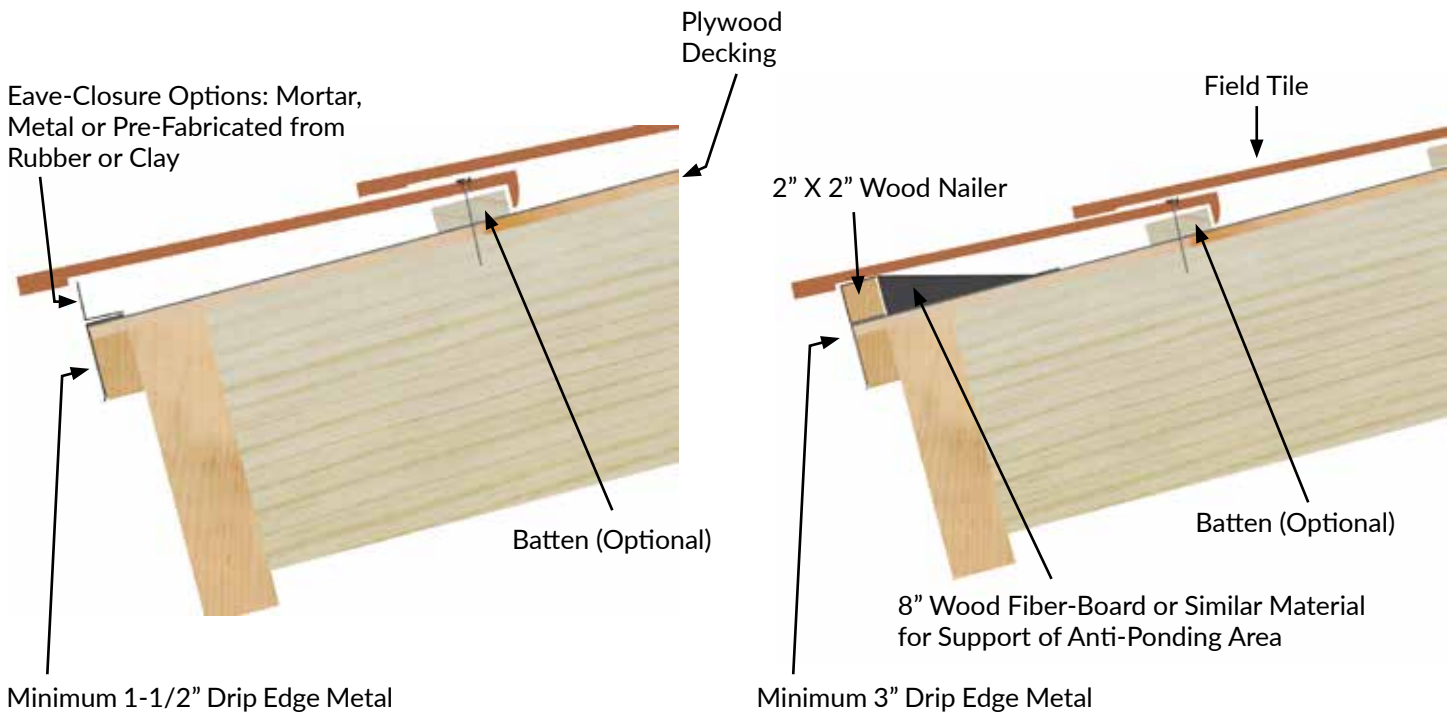

**NOTE** – Drawings are for illustrative purposes and do not reflect all methods of installation. Please refer to written text.

### STRUCTURAL HIP AND RIDGE SUPPORTS

OPTIONS: METAL BRACKETS AND/OR PLASTIC RIDGE SUPPORT

FHW-15

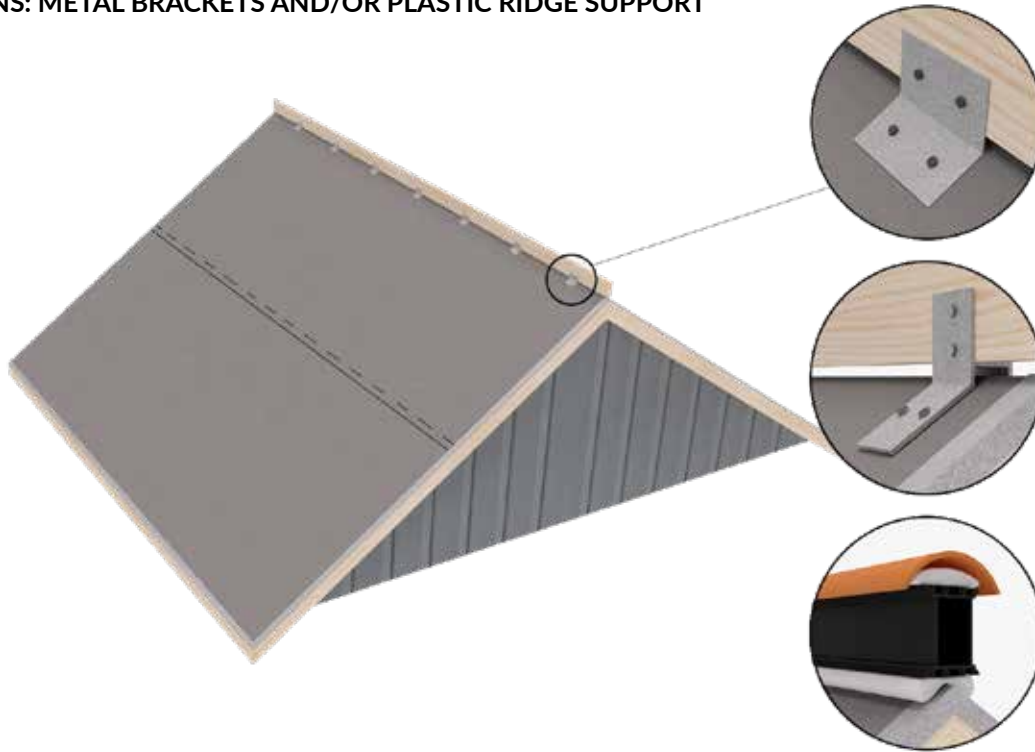

APPENDIX B

### WEATHER BLOCKING OPTIONS AT RIDGE

FHW-16

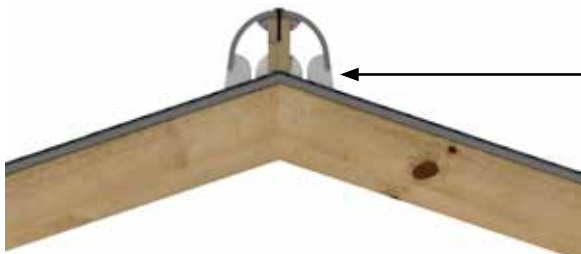

Adhere Wood Hip and Ridge Boards with Adhesive. Use Mortar or Foam Adhesive as Weather Blocking.

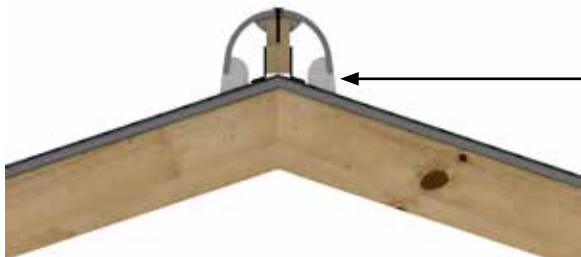

Mechanically Attached Wood Hip and Ridge Boards Using Metal Brackets. Use Mortar or Foam Adhesive as Weather Blocking.



Mechanically Attached Wood Hip and Ridge Boards Using Metal Brackets. Cover with Self-Adhered Weather Blocking.

**NOTE** – Drawings are for illustrative purposes and do not reflect all methods of installation. Please refer to written text.

**STRUCTURAL HIP AND RIDGE SUPPORT**

OPTIONS: METAL, WOOD AND PLASTIC

**FHW-17**

Underlayment Approved for Adhesive Applications

Wood Hip and Ridge Support Attachment with Code Approved Roof Tile Adhesive

Metal Hip and Ridge Support Frame Installed as per the Manufacturer's Product Approval

Plastic Ridge Support Used in Conjunction with Code Approved Roof Tile Adhesive

Seal All Nail Penetrations with Compatible Roof Cement Unless the Underlayment Meets ASTM D-1970 Sec. 7.9.

**Note:** Stacking of Nailer Boards may be Used. Maximum Thickness of 2" per Additional Nailer Board.

**STRUCTURAL HIP AND RIDGE SUPPORT**

OPTION: CODE APPROVED PRE-BAGGED MORTAR

**FHW-18**

Point Mortar to Desired Finish

Install Hip and Ridge Tile in a Continuous Bed of Code Approved Pre-Bagged Mortar. Mortar Shall Completely Fill the Entire Cavity and Provide a Bond with the Hip and Ridge Tile.

**Note:** SSTD 11-99 Code Compliant Documentation shall be provided when a continuous bed of code approved pre-bagged mortar is used for structural support in the installation of hip and ridge roof tile.

**NOTE** – Drawings are for illustrative purposes and do not reflect all methods of installation. Please refer to written text.

### RAKE TILE INSTALLATION

FHW-19

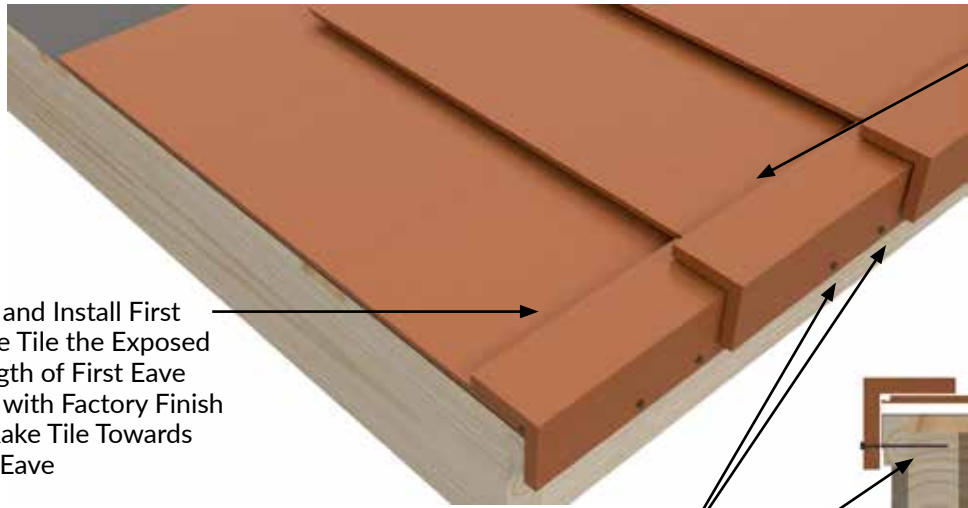

Abut Each Succeeding Rake Tile to Nose of the Field Tile Above and Maintain a Constant Headlap.

Cut and Install First Rake Tile the Exposed Length of First Eave Tile with Factory Finish of Rake Tile Towards the Eave

Fasten Rake Tile with a Minimum of Two 10d Nails and/or #8 screws. Fasteners to be of Sufficient Length to Penetrate the Frame a Min. of 3/4".



### CAP SHEET OVER PROTRUSION FLASHING

FHW-20

#### THREE STEP FLASHING OVER TWO-PLY UNDERLAYMENT AND SINGLE-PLY SYSTEM

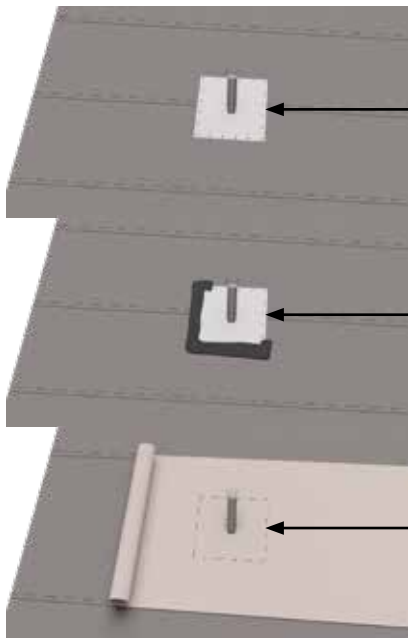

Step # 1 - Apply Flashing Over Protrusion and Fasten Over Base Sheet and/or Cap Sheet.

Step # 2 - Apply Flashing Over Protrusion and Seal with a Compatible Flashing Cement.

Step # 3 - Fully Adhered Cap Sheet Over Flashing. Fill Void at Base of Flashing with Adhesive.

Two-Step Application

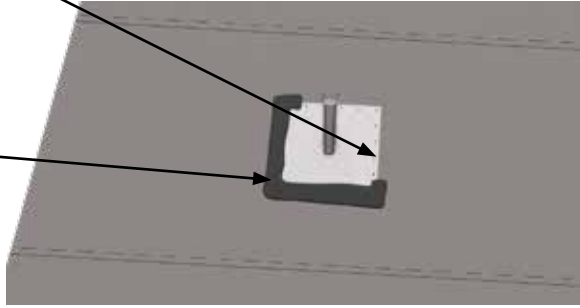

Single-Ply Underlayment

Two-Ply Underlayment

NOTE – Drawings are for illustrative purposes and do not reflect all methods of installation. Please refer to written text.

PIPES, VENTS, ETC.

FHW-21

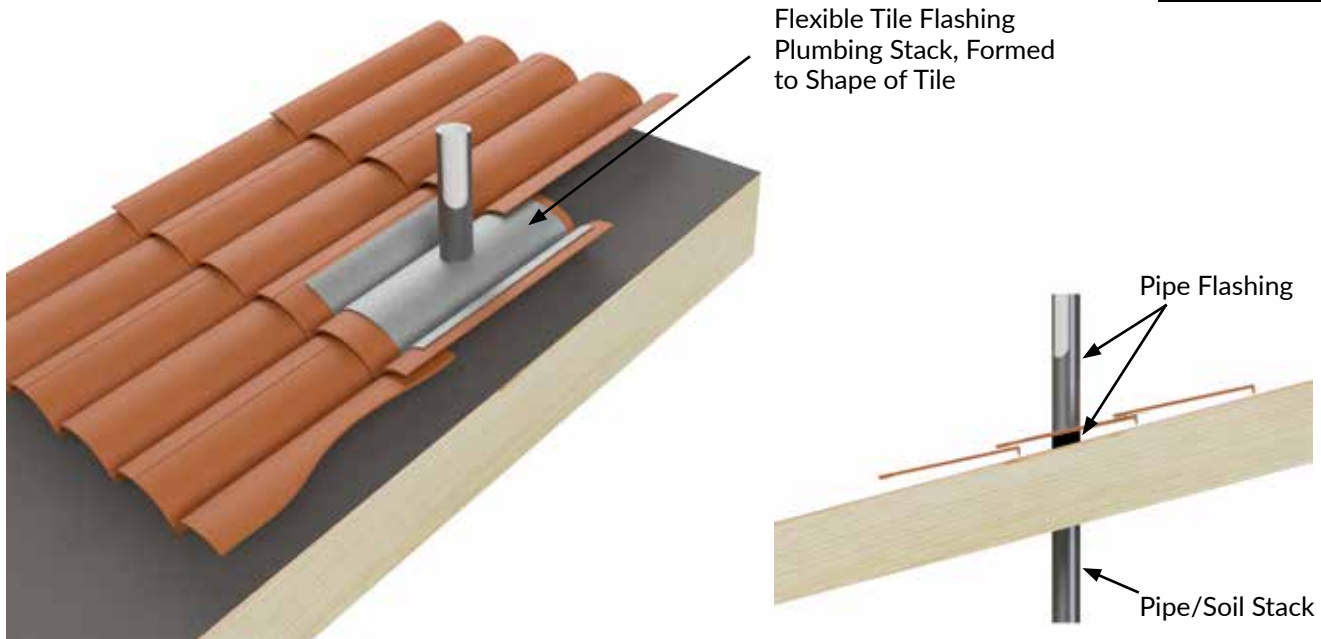

Note: Optional unless battens are used.

ROOF VENTS (OFF RIDGE VENTS & INTEGRATED VENTS)

FHW-22

VENTS TO BE INSTALLED AS PER VENT MANUFACTURER'S INSTALLATION WRITTEN INSTRUCTIONS

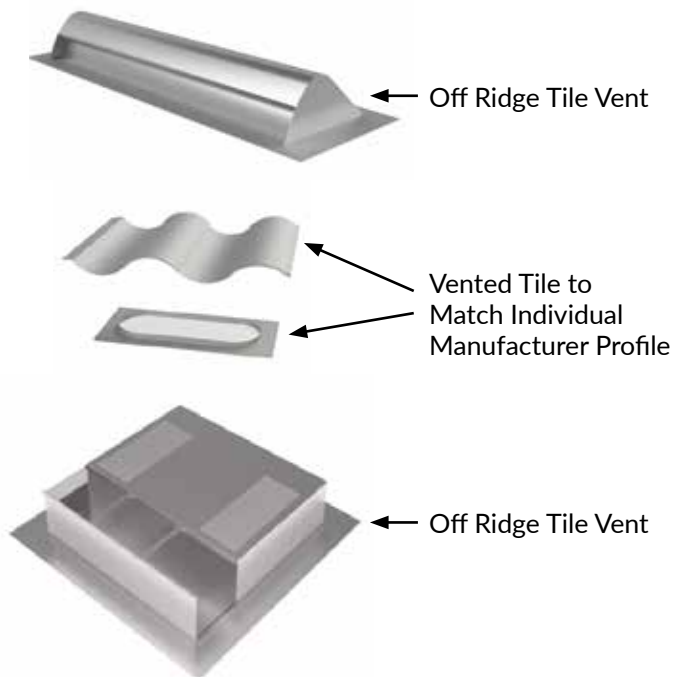

Note:

- All metal surfaces that the underlayment adheres to must be primed with a compatible primer.
- If a metal is to be installed under a single-ply underlayment, then prior to installing the metal, a separator sheet must be installed.
- All metal flashings without returns shall be fastened 6" O.C. with a min. 12-Gauge corrosion resistant roofing nails or other approved fasteners of compatible metals near the outside edge of the metal.

NOTE – Drawings are for illustrative purposes and do not reflect all methods of installation. Please refer to written text.

### BATTEN LAYOUT OPTIONS

FOR TILE WITH PROTRUDING ANCHOR LUGS

FHW-23

APPENDIX B

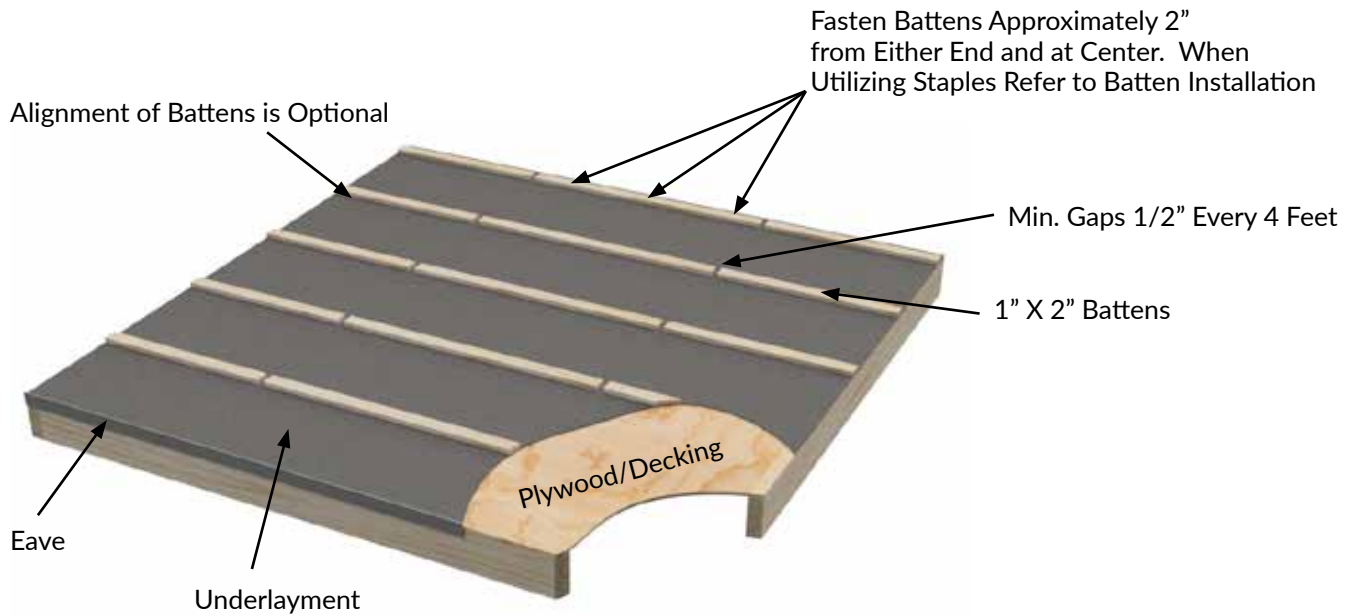

### IDENTIFICATION OF ROOF AREAS

FHW-24

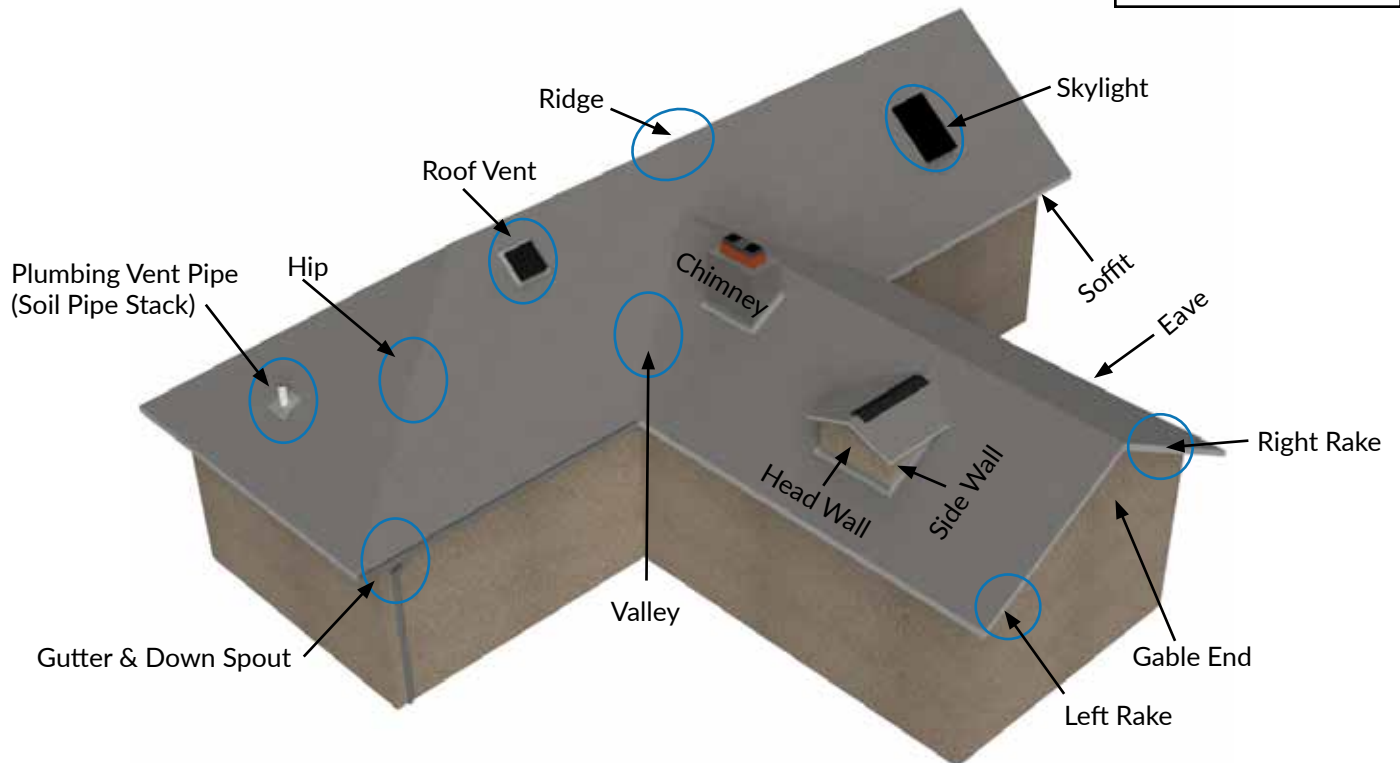

**NOTE** – Drawings are for illustrative purposes and do not reflect all methods of installation. Please refer to written text.

ESTABLISHING VERTICAL ALIGNMENT

FHW-25

APPENDIX B

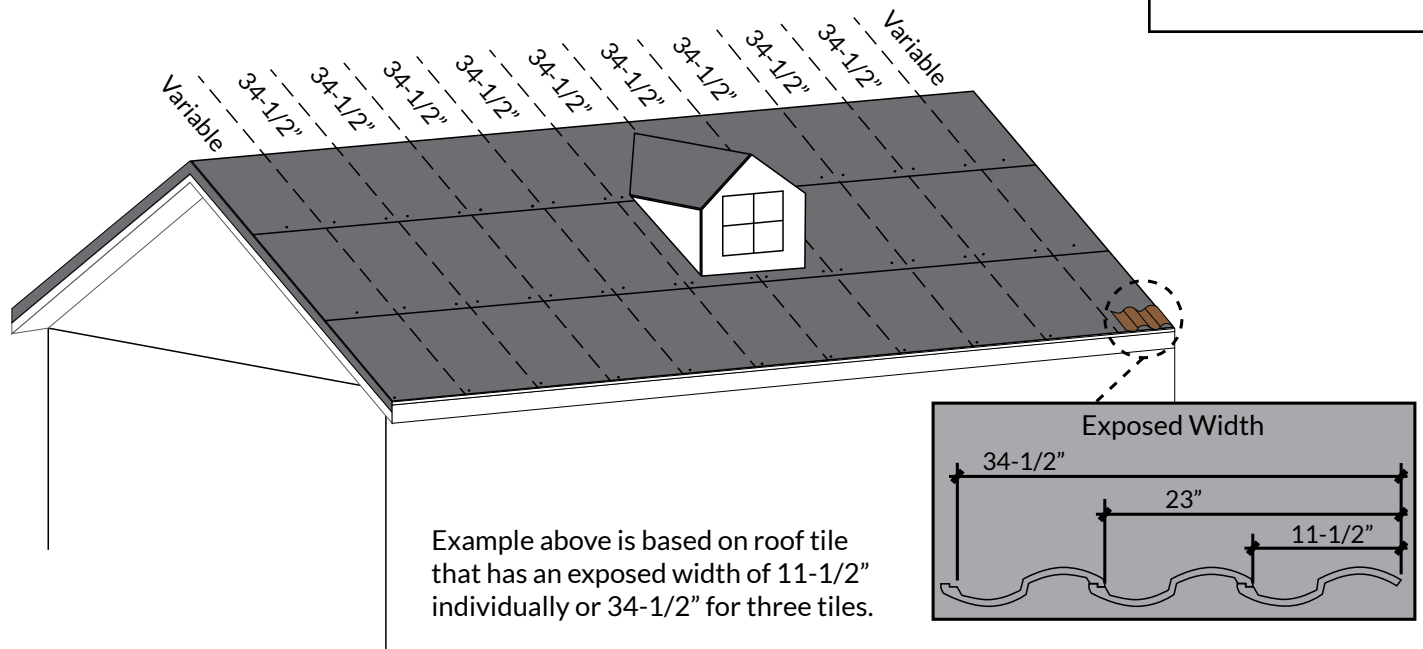

Example above is based on roof tile that has an exposed width of 11-1/2" individually or 34-1/2" for three tiles.

Vertical alignment on interlocking tiles is, for the most part, controlled by the natural seat of the interlocking channels of the adjacent tiles. It is important however to establish a true vertical alignment prior to application of field tiles to assure a symmetrical installation. Proper roof layout greatly enhances the appearance and performance of the installed roof and it serves to simplify and speed the application of the tile. A few minutes devoted to layout at the beginning of the job can result in significant savings of time and effort as the job progresses. On a gable roof installation, the first vertical guideline is established by installing the first three tiles of the eave course and measuring the distance from the leading edge of the third tile back to the rake edge. The increment is then marked at the ridge course and a chalk line is snapped to delineate the vertical guide.

The exposed width dimension of the tile is then determined and measured from the vertical guide as frequently as needed to maintain proper alignment. Most often this measurement is marked in three-tile increments. Vertical lines shall be perpendicular to the eave.

Mark a point at the eave line as close to the center of the hip section as possible. Measure a point away from either side of the center point (5'-10' if possible), making sure that both marks are the same distance from the center line. Using a tape measure or lines of exactly the same length, swing an arc away from each mark to intersect as high on the hip as possible. The intersection point of the arcs represents the high point of the vertical line above the mark made near the center of the eave line. A chalk line may be snapped to provide vertical reference. Incremental measurements may then be taken in either direction from this center line to provide guidelines for vertical alignment.

On the small hip sections, careful attention to horizontal alignment and proper tile placement is usually adequate to maintain vertical alignment. On larger roof sections, it is helpful to establish solid vertical alignment to ensure uniform appearance and ease of application.

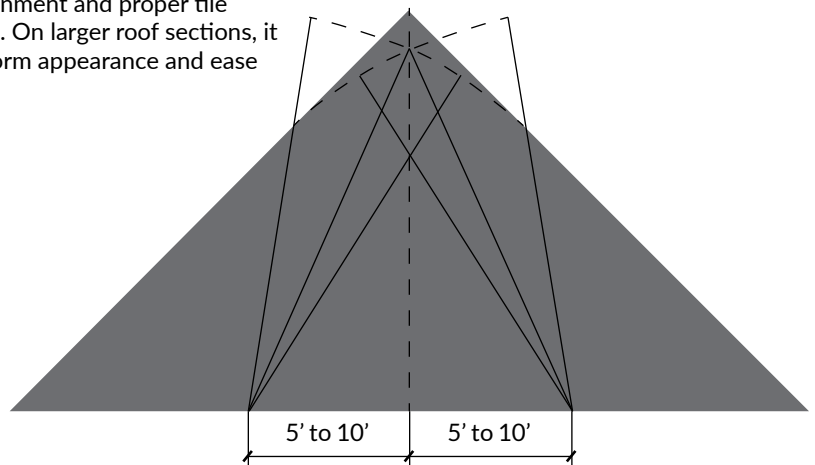
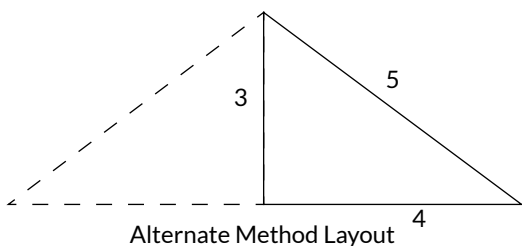

**NOTE** – Drawings are for illustrative purposes and do not reflect all methods of installation. Please refer to written text.

## ROOF LAYOUT

### UTILIZING SPECIALLY-MARKED MEASURING TAPE

FHW-26

To achieve optimum beauty, the area between the eave and ridge should be divided into equal tile courses when possible. Minimum 3" overlap must be maintained for all tiles unless design of tile precludes.

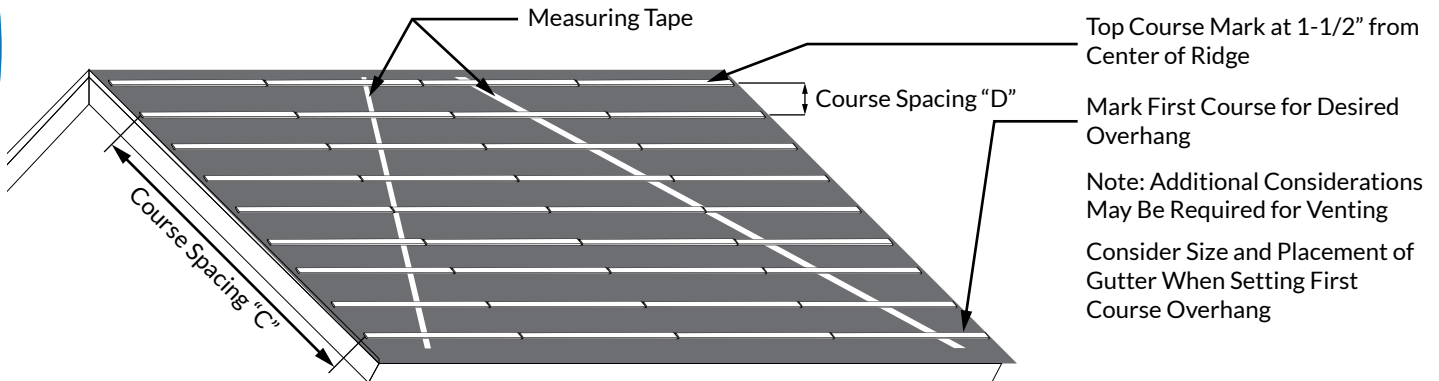

Top Course Mark at 1-1/2" from Center of Ridge

Mark First Course for Desired Overhang

Note: Additional Considerations May Be Required for Venting

Consider Size and Placement of Gutter When Setting First Course Overhang

#### Notes:

1. Using a full tile, determine desired overhang at eave and snap horizontal chalk line across roof at head end of tile or top of batten. Use of rain gutters and eave closures should be considered in determining tile overhang.
2. Snap a horizontal chalk line at the top of the roof 1-1/2" from the center of the ridge (adjust for direct deck).
3. With measuring tape, marked for maximum "exposed length" of tile being installed, measure vertically from the course nearest the ridge at either end of the roof (e.g., 14" for a 17" length tile).
4. If a mark on your tape does not fall exactly upon top line, move the tape to the left or the right until the next mark intersects the line.
5. Mark the deck at every mark on the tape.
6. Repeat this process at other end of roof.
7. Snap lines between marks on the deck. All courses will be equal with minimum recommended headlap maintained.
8. Repeat above steps on all roof planes.
9. Nail top of battens or tiles at each horizontal line.

## ROOF LAYOUT FOR CLAY DIAGONAL CUT ONE-PIECE S TILE

### Horizontal Layout

1. Using a full tile, determine desired overhang at eave and snap horizontal chalk line across roof at head end of tile. Use of rain gutters and eave closures should be considered in determining tile overhang.
2. At the top of the roof deck, mark a reference point by measuring 1-1/2" from the center of the ridge, plus the distance of one full course (e.g., 15" for a 18" length tile).
3. Measure up the roof slope to the reference point and divide by the manufacturer's maximum exposure in an effort to determine if the roof section will terminate with a full tile. Mark roof deck for each course of tile and snap chalk lines over entire section.
4. If roof section does not terminate with a full tile at the ridge, decrease the course exposure in small increments (typically 1/4") in attempt to finish with a full tile at the ridge (see note below).
5. If the last course does not terminate with a full tile, cut to dimension, as required, and fasten with mechanical fastener or other approved fastening method.

### Vertical Layout

1. To ensure proper vertical alignment, determine the manufacturer's stated maximum on-center spacing requirements and snap chalk lines as a reference point, typically the inside of the tile.
2. For gable end roof sections, determine the proper distance from left and right rakes and mark the eave and ridge section to align the edge of the tiles.
3. Measure between the two marks and divide by the manufacturer's stated maximum on-center spacing. If required, decrease the on-center spacing slightly in an effort to terminate with a full tile at the gable end(s). Ensure that the installed tiles are within the manufacturer's minimum/maximum on-center spacing requirements.

**Note:** Tiles are allowed, by ASTM C1167/C1492, for a plus-or-minus five percent variance from the manufacturer's stated "nominal dimensions." It is the installer's responsibility to verify the "delivered" roof tile dimensions prior to commencing with roof layout and to ensure that the tile is installed within the manufacturer's minimum headlap and on-center spacing requirements. Most diagonal-cut tiles will allow slight course exposure adjustments, typically 1/4" per tile.

*Drawing FHW-26 depicts the application of all tile profiles. Unless otherwise noted, it would apply to either concrete or clay tiles.*

**NOTE** – Drawings are for illustrative purposes and do not reflect all methods of installation. Please refer to written text.



ROOF LAYOUT – QUICK REFERENCE

FHW-26A

COURSE SPACING TABLE FOR TILES 16-1/2" TO 17" IN LENGTH

To achieve optimum beauty, the area between the eave and ridge should be divided into equal tile courses when possible. Minimum 3" overlap must be maintained for all tiles unless design of tile precludes.

COURSE SPACING "D" (REFER TO DRAWING FHW-26)

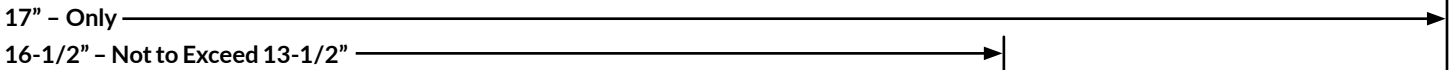

12-1/2"	12-5/8"	12-3/4"	12-7/8"	13"	13-1/8"	13-1/4"	13-3/8"	13-1/2"	13-5/8"	13-3/4"	13-7/8"	14"
2' 1"	2' 1-1/4"	2' 1-1/2"	2' 1-3/4"	2' 2"	2' 2-1/4"	2' 2-1/2"	2' 2-3/4"	2' 3"	2' 3-1/4"	2' 3-1/2"	2' 3-3/4"	2' 4"
3' 1-1/2"	3' 1-7/8"	3' 2-1/4"	3' 2-5/8"	3' 3"	3' 3-3/8"	3' 3-3/4"	3' 4-1/8"	3' 4-1/2"	3' 4-7/8"	3' 5-1/4"	3' 5-5/8"	3' 6"
4' 2"	4' 2-1/2"	4' 3"	4' 3-1/2"	4' 4"	4' 4-1/2"	4' 5"	4' 5-1/2"	4' 6"	4' 6-1/2"	4' 7"	4' 7-1/2"	4' 8"
5' 2-1/2"	5' 3-1/8"	5' 3-3/4"	5' 4-3/8"	5' 5"	5' 5-5/8"	5' 6-1/4"	5' 6-7/8"	5' 7-1/2"	5' 8-1/8"	5' 8-3/4"	5' 9-3/8"	5' 10"
6' 3"	6' 3-3/4"	6' 4-1/2"	6' 5-1/4"	6' 6"	6' 6-3/4"	6' 7-1/2"	6' 8-1/4"	6' 9"	6' 9-3/4"	6' 10-1/2"	6' 11-1/4"	7' 0"
7' 3-1/2"	7' 4-3/8"	7' 5-1/4"	7' 6-1/8"	7' 7"	7' 7-7/8"	7' 8-3/4"	7' 9-5/8"	7' 10-1/2"	7' 11-3/8"	8' 1/4"	8' 1-1/8"	8' 2"
8' 4"	8' 5"	8' 6"	8' 7"	8' 8"	8' 9"	8' 10"	8' 11"	9' 0"	9' 1"	9' 2"	9' 3"	9' 4"
9' 4-1/2"	9' 5-5/8"	9' 6-3/4"	9' 7-7/8"	9' 9"	9' 10-1/8"	9' 11-1/4"	10' 3/8"	10' 1-1/2"	10' 2-5/8"	10' 3-3/4"	10' 4-7/8"	10' 6"
10' 5"	10' 6-1/4"	10' 7-1/2"	10' 8-3/4"	10' 10"	10' 11-1/4"	11' 1/2"	11' 1-3/4"	11' 3"	11' 4-1/4"	11' 5-1/2"	11' 6-3/4"	11' 8"
11' 5-1/2"	11' 6-7/8"	11' 8-1/4"	11' 9-5/8"	11' 11"	12' 3/8"	12' 1-3/4"	12' 3-1/8"	12' 4-1/2"	12' 5-7/8"	12' 7-1/4"	12' 8-5/8"	12' 10"
12' 6"	12' 7-1/2"	12' 9"	12' 10-1/2"	13' 0"	13' 1-1/2"	13' 3"	13' 4-1/2"	13' 6"	13' 7-1/2"	13' 9"	13' 10-1/2"	14' 0"
13' 6-1/2"	13' 7-1/8"	13' 9-3/4"	12' 11-3/8"	14' 1"	14' 2-5/8"	14' 4-1/4"	14' 5-7/8"	14' 7-1/2"	14' 9-1/8"	14' 10-3/4"	15' 3/8"	15' 2"
14' 7"	14' 8-3/4"	14' 10-1/2"	15' 1/4"	15' 2"	15' 3-3/4"	15' 5-1/2"	15' 7-1/4"	15' 9"	15' 10-3/4"	16' 1/2"	16' 2-1/4"	16' 4"
15' 7-1/2"	15' 9-3/8"	15' 11-1/4"	16' 1-1/8"	16' 3"	16' 4-7/8"	16' 6-3/4"	16' 8-5/8"	16' 10-1/2"	17' 3/8"	17' 2-1/4"	17' 4-1/8"	17' 6"
16' 8"	16' 10"	17' 0"	17' 2"	17' 4"	17' 6"	17' 8"	17' 10"	18' 0"	18' 2"	18' 4"	18' 6"	18' 8"
17' 8-1/2"	17' 10-5/8"	18' 3/4"	18' 2-7/8"	18' 5"	18' 7-1/8"	18' 9-1/4"	18' 11-3/8"	19' 1-1/2"	19' 3-5/8"	19' 5-3/4"	19' 7-7/8"	19' 10"
18' 9"	18' 11-1/4"	19' 1-1/2"	19' 3-3/4"	19' 6"	19' 8-1/4"	19' 10-1/2"	20' 3/4"	20' 3"	20' 5-1/4"	20' 7-1/2"	20' 9-3/4"	21' 0"
19' 9-1/2"	19' 11-7/8"	20' 2-1/4"	20' 4-5/8"	20' 7"	20' 9-3/8"	20' 11-3/4"	21' 2-1/8"	21' 4-1/2"	21' 6-7/8"	21' 9-1/4"	21' 11-5/8"	22' 2"
20' 10"	21' 1/2"	21' 3"	21' 5-1/2"	21' 8"	21' 10-1/2"	22' 1"	22' 3-1/2"	22' 6"	22' 8-1/2"	22' 11"	23' 1-1/2"	23' 4"
21' 10-1/2"	22' 1-1/8"	22' 3-3/4"	22' 6-3/8"	22' 9"	22' 11-5/8"	23' 2-1/4"	23' 4-7/8"	23' 7-1/2"	23' 10-1/8"	24' 3/4"	24' 3-3/8"	24' 6"
22' 11"	23' 1-3/4"	23' 4-1/2"	23' 7-1/4"	23' 10"	24' 3/4"	24' 3-1/2"	24' 6-1/4"	24' 9"	24' 11-3/4"	25' 2-1/2"	25' 5-1/4"	25' 8"
23' 11-1/2"	24' 2-3/8"	24' 5-1/4"	24' 8-1/8"	24' 11"	25' 1-7/8"	25' 4-3/4"	25' 7-5/8"	25' 10-1/2"	26' 1-3/8"	26' 4-1/4"	26' 7-1/8"	26' 10"
25' 0"	25' 3"	25' 6"	25' 9"	26' 0"	26' 3"	26' 6"	26' 9"	27' 0"	27' 3"	27' 6"	27' 9"	28' 0"
26' 1/2"	26' 3-5/8"	26' 6-3/4"	26' 9-7/8"	27' 1"	27' 4-1/8"	27' 7-1/4"	27' 10-3/8"	28' 1-1/2"	28' 4-5/8"	28' 7-3/4"	28' 10-7/8"	29' 2"
27' 1"	27' 4-1/4"	27' 7-1/2"	27' 10-3/4"	28' 2"	28' 5-1/4"	28' 8-1/2"	28' 11-3/4"	29' 3"	29' 6-1/4"	29' 9-1/2"	30' 3/4"	30' 4"
28' 1-1/2"	28' 4-7/8"	28' 8-1/4"	28' 11-5/8"	29' 3"	29' 6-3/8"	29' 9-3/4"	30' 1-1/8"	30' 4-1/2"	30' 7-7/8"	30' 11-1/4"	31' 2-5/8"	31' 6"
29' 2"	29' 5-1/2"	29' 9"	30' 1/2"	30' 4"	30' 7-1/2"	30' 11"	31' 2-1/2"	31' 6"	31' 9-1/2"	32' 1"	32' 4-1/2"	32' 8"

Notes:

- Using a full tile, determine desired overhang at eave and snap horizontal chalk line across roof at head end of tile on direct deck or top of batten on batten installations. Use of rain gutters and eave closures should be considered in determining tile overhang.
- Snap a horizontal chalk line at the top of the roof 1-1/2" from the center of the ridge (adjust for direct deck).
- In spacing guide, find column containing nearest figure to the measurement between the eave and ridge course.
- Mark both ends of roof at course spacing shown in column.
- Snap chalk lines across roof at course markings.
- Nail top of battens to chalk line.

LOADING GUIDE EXAMPLE

FHW-27

APPENDIX B

The method of roof loading shown on this page represents the method of tile placement for efficient application, but is not intended to suggest that this is the only method that will work. Each applicator will have personal preferences for the stack location and spacing. The important aspect of the tile loading is to spread the load evenly across the roof while using the proper increments that assure that the proper amount of tile is loaded on roof.

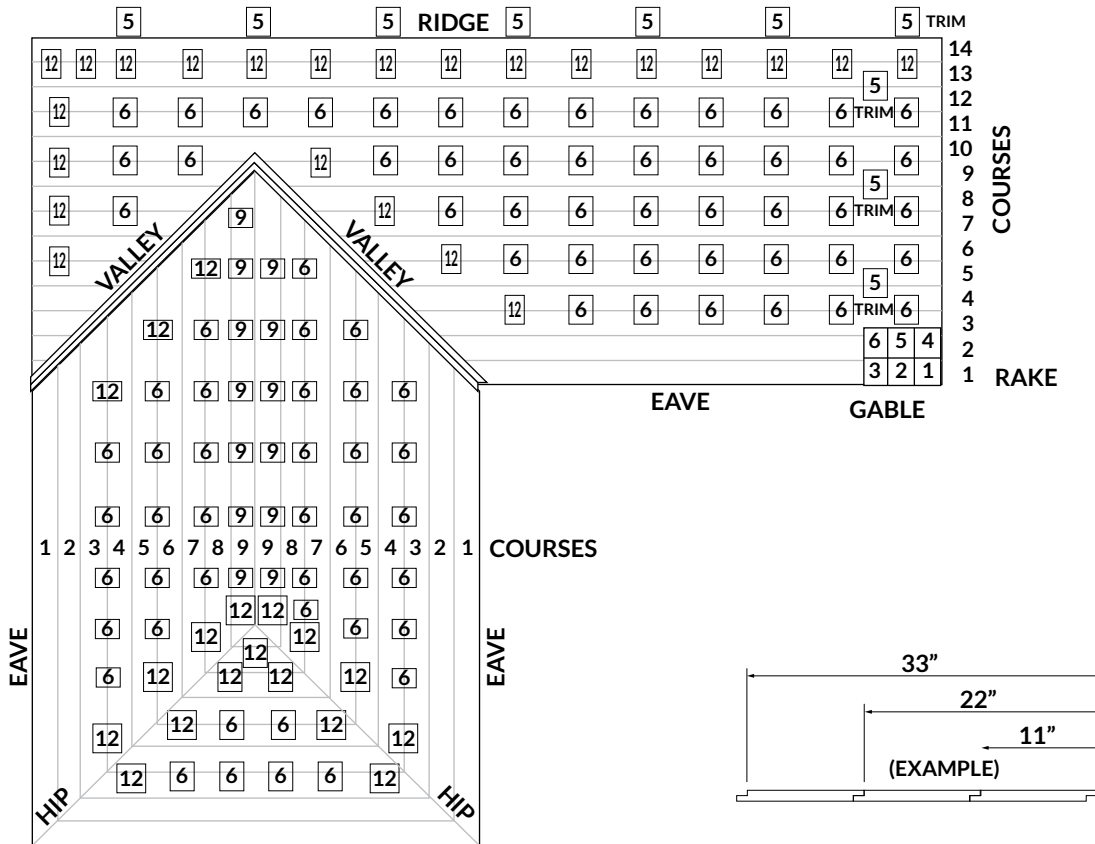

1. Course lines should be measured and chalked according to the roof layout recommendations before loading the tile.
2. Determine the approximate number of tiles needed for each section of roof.
3. Spacing of the tile stacks is determined by the width of the exposed tile times the number of tiles being fed per course, for example in the attached schematic, each stack of tiles will feed two courses, three tiles wide. If each tile is exposed 11", then the stack will be placed 33" O.C. If the stack feeds three courses, two tiles wide, then the stack would be 22" O.C.
4. Starting with the third course from the eave, and continuing with alternate courses, distribute tiles (usually 6 per stack) over the roof leaving approximately 20" from gable ends and between stacks.
5. When total number of courses is an even number, stack 12 tiles on ridge stacks. When total number of courses is an odd number, stack 9 tiles on ridge stack.
6. On right side of the hips and valleys, stack 12 tiles. Maintain at least 24" between tile stacks and left side of valley. Reverse for tiles laid left to right.
7. Distribute trim tiles when loading field tiles. Trim tiles are in stacks of 5 at 70" O.C. Load ridge tile on side of roof to be applied last.
8. To achieve a pleasant, random blend of color for your job, care should be taken upon loading to mix the tiles.

Drawing shown depicts the application of all tile profiles. Unless otherwise noted it would apply to either concrete or clay tiles.

**NOTE** – Drawings are for illustrative purposes and do not reflect all methods of installation. Please refer to written text.

## GLOSSARY

**Glossary of Terms and Definitions** – The terms and definitions contained herein are used in the context of concrete and clay tile roofing. It should be understood by the reader that some of the terms and definitions included herein may also have different meanings and/or interpretations when used in context with other types of roof constructions, coverings, roofing materials or systems.

**ABUTMENT** – The intersection between a roof panel and a vertical wall.

**ACCESSORIES** – Secondary or additional materials used to contribute to an end result or effect.

**ACQ** – (Alkaline Copper Quaternary) A chemical wood preservative with high levels of copper, making ACQ treated lumber highly corrosive to common steel.

**ADHESIVES** – A bonding agent to join two surfaces for the purpose of permanent attachment as approved by the local building official.

**AERODYNAMIC MOMENT** – A quantity which expresses the effect of a force applied at a particular point in relation to a specific point or axis.

**ALTERNATIVE MEMBRANES** – Any product consisting of at least two water-shedding layers applied to a sloped roof prior to the application of a prepared roof covering having been tested in compliance with the building code. The primary purpose of an underlayment is defined as a water-shedding layer to function in combination with a prepared roof covering.

**ANCHOR SHEET** – The first sheet applied to a roof deck by nailing, mopping or other approved attachment; often called a “base sheet.”

**ANTI-PONDING** – A method to ensure positive drainage over raised fascia/starter strip at eave.

**APA** – American Plywood Association.

**APPLICATION RATE** – The quantity (mass, volume or thickness) of material applied per unit area.

**APPROVED PRODUCTS** – Includes all products tested and evaluated for the approved application.

**APRON FLASHING** – A flexible or rigid flashing installed at head of tile onto a vertical surface.

**ASCE** – American Society of Civil Engineers.

**ASPHALT** – A bituminous waterproofing agent applied to roofing materials during the manufacturing process

or in the assembly/construction of a roof covering.

**ASPHALT FELT** – An asphalt saturated felt or an asphalt coated felt.

**ASPHALT ROOFING CEMENT** – A mixture of asphaltic materials, solvents and graded mineral, organic or inorganic fillers.

**ASPHALT TYPE III** – Also referred to as “STEEP ASPHALT.” It is a grade of asphalt designed for sloped roofing applications and complying with ASTM D312, TYPE III.

**ASPHALT TYPE IV** – Also referred to as “SPECIAL STEEP ASPHALT.” It is a grade of asphalt designed for sloped roofing applications complying with ASTM D312, TYPE IV.

**ASTM** – American Society for Testing and Materials.

**AWPA** – American Wood Preservers Association.

**BACKNAILING** – The practice of nailing roll roofing so that the nails are placed in the underlying roofing and are covered by the overlapping course of roll roofing.

**BARGE BOARD** – A board, often ornate, fastened to the projecting gables of a roof to protect or finish other timber.

**BASE FLASHING** – That portion of the flashing attached to or resting on the roof surface or deck.

**BASE SHEET** – The bottom or first ply of a roof system assembly over which subsequent roofing plies are applied.

**BATTEN EXTENDER** – Product designed to cantilever to center of valley and/or wall tray, nailed to batten with no penetration through metal; designed to elevate tile above valley and flashing.

**BATTENS** – Fastening strips installed to the underlayment or sub-roof to which roof tiles are then installed.

**BEDDING** – Refers to the installation of roof tiles with mortar or polyurethane foam paddy and is structural in

nature for basic securement.

**BOND** – The adhesive and cohesive forces holding two roofing components in intimate contact.

**CAP SHEET** – Top or final ply of an underlayment system.

**CLOSED VALLEY** – see VALLEY.

**COATINGS** – A layer of substance spread over a surface for protection or decoration.

**CODE APPROVED** – Any product that has FBC Product Approval for that specific application.

**COLD PROCESS ROOFING** – A continuous, semi-flexible membrane consisting of plies of felts, mats or fabric that are laminated on a roof with alternate layers of cold-applied mastic.

**CONCEALED NAIL METHOD** – see BACKNAILING.

**COUNTER FLASHING** – A rigid or flexible material secured on or into a wall, curb, pipe, rooftop unit or other surface to cover and protect the upper edge of a base flashing and its associated fasteners.

**COURSE** – A row of tiles or roll roofing running parallel to the eave.

**COVERAGE** – The surface area (in square feet) to be continuously covered by a specific roofing material, with allowance made for a specific lap.

**CRICKET** – A peaked saddle construction located at the back (high side) of a chimney (or other accessory) to deflect the flow of water around the chimney.

**CROSS BOND METHOD** – A method of installing tiles so that the side laps of the tiles are staggered to the preceding course.

**DECK** – The surface installed over the structural framing members to which roofing is applied. Another name for sheathing. May be of wood boards, plywood or other approved material.

**DRIP EDGE** – A non-corrosive material (usually of galvanized steel sheet metal, stainless steel, copper or aluminum) used along the roof perimeter to allow water run-off to drip clear of the underlying construction.

**EAVE** – The horizontal lower edge of a sloped roof.

**EAVE CLOSURE** – A prefabricated EPDM rubber, metal, concrete or clay material or mortar to elevate the first course of tiles and to enclose the cavity formed by the tiles at the eave.

**EAVE METAL** – A metal flashing used to terminate the eave edge of a pitched roof.

**END LAP** – The lap joint at the end of a ply of roofing felt or membrane.

**EXPOSURE B** – For buildings with a mean roof height of less than or equal to 30 ft (9.1 m), Exposure B shall apply where the ground surface roughness, as defined by Surface Roughness B, prevails in the upwind direction for a distance greater than 1,500 ft (457 m). For buildings with a mean roof height greater than 30 ft (9.1 m), Exposure B shall apply where Surface Roughness B prevails in the upwind direction for a distance greater than 2,600 ft (792 m) or 20 times the height of the building, whichever is greater.

**EXPOSURE C** – Exposure C shall apply for all cases where Exposures B or D do not apply.

**EXPOSURE D** – Exposure D shall apply where the ground surface roughness, as defined by Surface Roughness D, prevails in the upwind direction for a distance greater than 5,000 ft (1,524 m) or 20 times the building height, whichever is greater. Exposure D shall also apply where the ground surface roughness immediately upwind of the site is B or C and the site is within a distance of 600 ft (183 m) or 20 times the building height, whichever is greater, from an Exposure D condition as defined in the previous sentence.

**FABRIC** – A woven cloth of organic or inorganic filament, threads or yarns. The prevailing types are either cotton or fiberglass (also often referred to as “membrane”).

**FASCIA** – An ornamental board used to cover the rafter or truss end at the eave.

**FBC** – Florida Building Code.

**FELT** – A flexible or semi-flexible sheet manufactured for use as an underlayment.

**FINISHED SHEET** – A completed layer of underlayment previously installed and completed.

**FISHMOUTH** – (1) A half-cylindrical or half-conical opening or void in a lapped edge or seam, usually

caused by wrinkling or shifting of plywood sheets during installation. (2) In shingles, a half conical opening formed by a cut edge.

**FLANGE** – The projecting edge of a rigid or semi-rigid component, such as a metal flashing flange, skylight flange, flashing boot flange, etc.

**FLASHING** – A rigid or flexible material used to prevent water infiltration at roof projections and to redirect water from walls, chimneys, valleys, etc.

**FLASHING CEMENT** – A premium grade of asphalt roofing cement – see ASPHALT ROOFING CEMENT.

**FLAT/LOW PROFILE TILE** – Defined as those tiles with less than a 1/2" rise.

**FOAM PADDY** – A prepared polyurethane foam adhesive mixture used to adhere a roof tile to the underlayment.

**FRC** – Florida Residential Code.

**FRSA** – Florida Roofing and Sheet Metal Contractors Association, Inc.

**GABLE ROOF** – A roof design which has sloping sides and vertical ends.

**GALVANIZED** – A zinc coating to prevent the rusting of steel or iron.

**HEAD WALL** – Vertical wall intersecting roof plane at upper slope.

**HEADLAP** – The measurement of the overlap between a course of roofing components and the course above.

**HIGH PROFILE TILE** – Tiles having a rise to width ratio greater than 1/2" rise (measured in installed conditions).

**HIP AND/OR RIDGE MEMBER** – Wood, metal or plastic frame installed on a hip or ridge to provide a surface for installation of hip and ridge tiles.

**HIP ROOF** – The exterior sloping ridge formed by the intersection of two inclined roof surfaces.

**HOT MOP SYSTEM** – Refers to a multi-ply sub-roof system where one or more plies are adhered to an anchor sheet in hot asphalt.

**HURRICANE CLIPS** – See STORM CLIP.

**HVHZ** – High Velocity Hurricane Zone of the FBC.

**IBC** – International Building Codes.

**IRC** – International Residential Codes.

**IMPORTANCE FACTOR** – A value used in calculating wind loads that are determined by location as well as building occupancy and structure category.

**INTERLOCKING TILE** – Those tiles with a system of ribs or grooves enabling the lateral joining of adjacent tiles in the same horizontal course, with the overlapping lock covering the underlapping lock.

**JOB SITE MIX** – Any non-pre-bagged mortar meeting ASTM C270 for cement, sand and proportioning mixed at a job site and not bagged under the quality control of the mortar manufacturer.

**KICKER** – See WATER DIVERTER.

**"L" FLASHING** – See FLASHING.

**LOW PROFILE TILE** – Flat tiles having a top surface rise equal to or less than 1/2".

**MASTIC** – See ASPHALT ROOF CEMENT.

**MEAN ROOF HEIGHT** – The average elevation above grade height measured between the eave and ridge of a roof area.

**MEDIUM PROFILE TILE** – Tiles having a rise greater than 1/2" and a rise-to-width ratio of less than or equal to 1:5 (measured in installed conditions).

**MEMBRANE** – See FABRIC.

**MINERAL SURFACED ROLL ROOFING** – A prepared organic felt with granular surfaced finish, minimum 74# per 100 square feet, commonly called 90# or No. 90.

**MODIFIED BITUMEN** – Composite sheets consisting of a copolymer modified bitumen often reinforced and sometimes surfaced with various types of fibers, foils and mats.

**MONOSLOPE ROOF** – A roof design consisting of a single sloping roof deck.

**MORTAR PADDY** – A prepared mortar mixture used to adhere a roof tile to the underlayment.

**NINETY-POUND ROLL ROOFING (90#)** – See MINERAL SURFACED ROLL ROOFING.

**NON-INTERLOCKING TILE** – Those tiles without restrictive ribs, grooves or channels at the side laps.

**OPEN VALLEY** – See VALLEY.

**OVERHANG** – That portion of the tile which extends beyond the eave.

**PAN FLASHING** – Similar in profile shape to an “L” flashing, but with a return designed/fabricated to the outside horizontal edge. This type of flashing is used to contain water flow.

**PENETRATIONS** – An opening in the roof deck.

**PHASED APPLICATION** – The installation of a roof system or waterproofing system during two or more set time intervals.

**PITCH** – The degree of roof incline expressed as a ratio of the rise (vertical), in feet, to the run or span (horizontal), in feet. (Example – 2:12)

**PLASTIC CEMENT** – see ASPHALT ROOF CEMENT.

**PLY** – The number of layers of roofing (e.g., One-ply, Two-ply).

**POINT-UP** – The application of mortar to fill voids to various ends, sides and angles of a tile roof, which are non-structural in nature.

**PRE-BAGGED MORTAR** – Any mortar where the proportions are mixed and bagged under the quality control of the mortar manufacturer and has been issued a FBC Product Approval tested to SSTD 11-99.

**RAFTER** – The supporting framing member immediately beneath the deck, sloping from the ridge to the wall plate.

**RAKE** – The outside edge of a sloped roof at the gable.

**REGLET** – A groove in a wall or other surface adjoining a roof surface for the use of installing a counter flashing.

**RIDGE** – The uppermost horizontal external angle formed by the intersection of two sloping planes of the roof.

**RIDGEBOARD** – see HIP AND RIDGE BOARD.

**RING SHANK FASTENERS** – A slim, pointed piece of metal with ring-formed body to increase gripping strength used to mechanically fasten materials.

**ROOF TILE ADHESIVE** – A roof tile adhesive product that has been issued FBC Product Approval tested to SSTD 11-99.

**SADDLE** – A small structure that helps channel water to a point or around an obstruction. SEE CRICKET.

**SANDWICHED** – To place or insert an object between two other objects of differing character or quality.

**SATURATED FELT** – Roofing felt that had been partially saturated with asphalt.

**SELVAGE** – A specially defined edge of the material that is designed for some special purpose, such as overlapping or seaming.

**SEPARATOR SHEET** – A separate sheet of underlayment inserted on roof deck.

**SHEATHING** – Exterior grade wood boards used as a roof deck material.

**SIDE LAP** – The width of the section of a tile containing the under lap.

**SKIRT FLASHING** – A rigid or flexible flashing used to redirect water from a pre-formed flashing onto the tile surface.

**SLIP SHEET** – A separator sheet of underlayment inserted on the roof deck.

**SLIPPAGE** – Relative lateral movement of roll roofing installed on sloped roof often occurring due to not backnailing the roll roofing.

**SLOPE** – The degree of roof incline expressed as a ratio of the rise in inches to the run in inches. (Example – 2:12)

**SMOOTH SHANK FASTENERS** – A slim, pointed piece of metal with a smooth body used to mechanically fasten materials.

**SOAKER FLASHING** – A rigid or flexible flashing used at intersecting planes.

**SOIL PIPE** – A plumbing vent pipe that penetrates the plane of the roof.

**SQUARE** – A unit of roof measure equivalent to 100 square feet.

**STORM CLIPS** – A device attached near or on the nose end of a tile to inhibit the uplift forces of wind.

**STRAIGHT BOND METHOD** – A method of installing tiles so that the side laps of the tiles are in direct line to the preceding course.

**STRETCH-OUT** – The overall dimension of sheet metal before breaking/bending.

**STRUCTURAL SUPPORT** – Any wood, metal, plastic or other code approved product used as a means to transfer the loads of an attached hip and ridge tile to the substrate.

**SURFACE ROUGHNESS B** – Urban and suburban areas, wooded areas or other terrain with numerous closely spaced obstructions, having the size of single-family dwellings or larger.

**SURFACE ROUGHNESS C** – Open terrain with scattered obstructions having heights generally less than 30 feet. This category includes flat, open country, grasslands and all water surfaces in hurricane prone regions.

**SURFACE ROUGHNESS D** – Flat, unobstructed areas and water surfaces. This category includes smooth mud flats, salt flats and unbroken ice.

**SWEAT SHEET** – The first ply of underlayment installed the length of a flashing prior to the application of subsequent horizontal plies.

**TAPERED CANT STRIP** – A beveled strip used for support behind a raised fascia or starter strip to modify the angle at the eave.

**TILE FACTOR** – the exposed area of a tile that is subject to wind forces in the overall uplift calculations.

**TILE HEADLAP** - The dimension by which the overlap of the nose end of a tile covers the head end of tile in the row of tiles immediately under it.

**TIN TAG** – A small sheet metal disc through which a fastener is driven into the substrate to secure underlayment.

**TRANSITIONAL FLASHING** – Sheets consisting of metal and/or flexible material used to divert water properly to adjacent roof tile.

**TRI** – Tile Roofing Industry Alliance, formerly the (TRI) Tile Roofing Institute and the (RTI) Roof Tile Institute.

**UNDERLAYMENT** – One or more water-shedding layers of roofing applied to a sloped roof prior to the installation of roof tiles.

**UNDERLAYMENT HEADLAP** – The dimension by which a course of the underlayment overlaps the preceding course.

**VALLEY** – The internal angle formed by the intersection of two sloping roof planes.

- **CLOSED VALLEY** – A method of installing roof tiles where tiles are cut mitered and installed to a close tight fit.
- **OPEN VALLEY** – A method of installing roof tiles where tiles are cut mitered and installed so that a gap or trough is created to assist in the flow/drainage of water run-off.

**VENT** – Any outlet for air that protrudes through the roof deck.

**WATER DIVERTER** – A flashing that directionally changes water flow.

**WEEP HOLE** – Openings in the eave closure and/or certain ridge conditions that allow for moisture drainage and air ventilation.











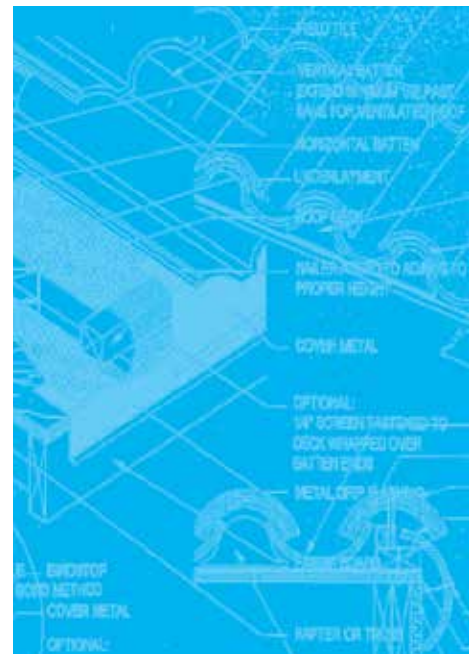

PO Box 4850  
 Winter Park, FL 32793  
 407-671-3772 ext. 100  
[frsa@floridarroof.com](mailto:frsa@floridarroof.com)  
[www.floridarroof.com](http://www.floridarroof.com)



2150 N 107th St. Ste 205  
 Seattle, WA 98133  
 206-209-5300  
[info@tileroofing.org](mailto:info@tileroofing.org)  
[www.tileroofing.org](http://www.tileroofing.org)